



Compliance Evaluation Report



REPORT No.: CSSC/BOS/005

ISSUED DATE: March 9, 2023

APPLICANT : SolaX Power Network Technology (Zhejiang) Co., Ltd.
No.288, Shizhu Road, Tonglu Economic Development Zone,
Tonglu City, Zhejiang Province, 310000 P. R. CHINA

SUBMITTED TO : Same as above

PRODUCT : PV grid-connected inverter

BRAND : SOLAX

MODEL : X1-MINI-1.5K-G4

Scope :

This report provides opinions for equipment compliance with the applicable standards/regulations stated in the following section. The purpose of compliance evaluation is to manifest that custom-made or imported equipment complies with the requirements of relevant standards/regulations in terms of necessary functions and settings. Local utility normally requires these opinions as a prerequisite for the first synchronization approval.

The opinions are based on CSSC's evaluation of the technical evidence provided by the applicant and equipment manufacturer.

Standards/regulations :

Provincial Electricity Authority's Regulation on the Power Network System Interconnection Code B.E.2559 (2016)

Technical evidence :

Test results, product specifications and other related documents provided by the applicant

(Mr. SITTICHAJ MUNGONRIT)
TEST ENGINEER

(Mr. BALLANG MUENPINIJ)
HEAD of BOS TESTING UNIT

(Dr. MANIT SEAPAN)
TESTING DEPARTMENT MANAGER

(Assoc. Prof. Dr. ANAWACH SANGSWANG)
DEPUTY DIRECTOR of ACADEMIC AFFAIRS

- REMARK: 1. The authorized CSSC staff signature through electronic means shall have the same validity as a manually executed signature to the fullest extent of a paper-based report issued by CSSC.
2. This report is digitally signed only on the first page and does not need to be signed on all pages.



Compliance Evaluation Report



REPORT No.: CSSC/BOS/005

ISSUED DATE: March 9, 2023

Product description

Brand: SOLAX
Model: X1-MINI-1.5K-G4

Technical specifications:

Output		Input	
Voltage	220/230/240V	Max. voltage	450V
Frequency	50/60Hz nom.	Voltage range	40 – 450V MPPT
Current	6.5A nom.	Current	16Amax.
Power	1500W nom.	Power	3000W max.

Remark: Referred to APPENDIX B.

Compliance case verdicts

Complied: Submitted result complies with the requirement.
Does not comply: Submitted result does not comply with the requirement.
N/A: Not Applicable

General remarks

This report shall not be reproduced, except in full, without the written approval of CES Solar Cells Testing Center (CSSC)

This report consists of the following documents:

- Test Compliance Validation Report
- APPENDIX A1. – List of documents from the TÜV Rheinland (Shanghai) Co., Ltd.
- APPENDIX A2. – PEA Grid Code Compliance Table.
- APPENDIX B. – X1 Series User Manual 0.6kW - 3.3kW
- APPENDIX C. – TÜV Rheinland's Report No: CN23Y4BO 001.
- APPENDIX D. – Laboratory Accreditation Certificate No. CNAS L3038

This report is provided without representation, warranty, or guarantee of any kind, expressed, or implied, and the CSSC provides no endorsement for any evaluated equipment, product, system or service described herein. CSSC accepts no responsibility whatsoever arising in any way from any and all use and reliance on the information contained in this report.



Compliance Evaluation Report



REPORT No.: CSSC/BOS/005

ISSUED DATE: March 9, 2023

Test Compliance Validation				
Technical Consideration Criteria			Submitted result - Remark	Compliance verdict / Technical comment
1	Active power control (Topic No. 12.1).	A connect requestor must design an Active Power Control System to help maintaining a specified voltage level. The system must be able to decrease the electric power from 100% to 0% on a 10% per minute manner.	<p>The inverter is able to decrease the active power from 100% to 0% of nominal active power as well as be able to 10% step decrease.</p> <p>The interval time of decreasing the active power from 100% to 0% is 596s.</p> <p>See APPENDIX C. page 94, 12. Active power control and page 169</p>	Complied ⁽¹⁾



Compliance Evaluation Report



REPORT No.: CSSC/BOS/005

ISSUED DATE: March 9, 2023

Test Compliance Validation													
Technical Consideration Criteria			Submitted result - Remark	Compliance verdict / Technical comment									
2	Reactive Power control (Topic No. 8.1.2).	<p>For a system with a converter, the power factor must be adjustable and controllable as demonstrated in the table below.</p> <p>Power Factor Adjustment and Reactive Electrical Power Control in System with Converter</p> <table border="1"> <thead> <tr> <th>Voltage Level at the Interconnection Point</th> <th>Ability to adjust the Power Factor at rated power input</th> <th>Reactive Power Control Methods</th> </tr> </thead> <tbody> <tr> <td>1) Low Voltage 2) Medium or High Voltage (Generation Capacity \leq 500 kW)</td> <td>0.95 lagging - 0.95 leading or better</td> <td>At least one method: A fixed displacement factor $\cos \theta$</td> </tr> <tr> <td>3) Medium to High Voltage (Generation Capacity $>$500 kW)</td> <td>0.90 lagging to 0.90 leading or better</td> <td>At least two methods: 1) A fixed displacement factor $\cos \theta$ 2) A variable reactive power depending on the voltage Q(U)</td> </tr> </tbody> </table>	Voltage Level at the Interconnection Point	Ability to adjust the Power Factor at rated power input	Reactive Power Control Methods	1) Low Voltage 2) Medium or High Voltage (Generation Capacity \leq 500 kW)	0.95 lagging - 0.95 leading or better	At least one method: A fixed displacement factor $\cos \theta$	3) Medium to High Voltage (Generation Capacity $>$ 500 kW)	0.90 lagging to 0.90 leading or better	At least two methods: 1) A fixed displacement factor $\cos \theta$ 2) A variable reactive power depending on the voltage Q(U)	<p><u>Generation Capacity \leq 500 kW</u></p> <p>1. A fixed displacement factor $\cos \theta$</p> <p>1.1 The inverter is adjustable and controllable at 0.95 lagging power factor.</p> <p>- 10% Pn : 150.6W and -51.7VAr</p> <p>- 100% Pn : 1528.7W and -503.7VAr</p> <p>1.2 The inverter is adjustable and controllable at 0.95 leading power factor.</p> <p>- 10% Pn : 155.7W and 41.4VAr</p> <p>- 100% Pn : 1528.7W and 507.8VAr</p> <p>See APPENDIX C. page 76 - 78, 6.1. A fixed displacement factor $\cos \emptyset$.</p>	Complied ⁽¹⁾
Voltage Level at the Interconnection Point	Ability to adjust the Power Factor at rated power input	Reactive Power Control Methods											
1) Low Voltage 2) Medium or High Voltage (Generation Capacity \leq 500 kW)	0.95 lagging - 0.95 leading or better	At least one method: A fixed displacement factor $\cos \theta$											
3) Medium to High Voltage (Generation Capacity $>$ 500 kW)	0.90 lagging to 0.90 leading or better	At least two methods: 1) A fixed displacement factor $\cos \theta$ 2) A variable reactive power depending on the voltage Q(U)											



Compliance Evaluation Report



REPORT No.: CSSC/BOS/005

ISSUED DATE: March 9, 2023

Test Compliance Validation				
Technical Consideration Criteria			Submitted result - Remark	Compliance verdict / Technical comment
2	Reactive Power control (Topic No. 8.1.2).	(Cont.)	<u>Generation Capacity > 500 kW</u> 1. A fixed displacement factor $\cos \theta$ 1.1 The inverter is adjustable and controllable at 0.90 lagging power factor. - 1.2 The inverter is adjustable and controllable at 0.90 leading power factor.	N/A



Compliance Evaluation Report



REPORT No.: CSSC/BOS/005

ISSUED DATE: March 9, 2023

Test Compliance Validation				
Technical Consideration Criteria			Submitted result - Remark	Compliance verdict / Technical comment
2	Reactive Power control (Topic No. 8.1.2).	(Cont.)	<p><u>Generation Capacity > 500 kW</u></p> <p>2. A variable reactive power depending on the voltage Q(U)</p> <p>2.1 Voltage set point 0.93Vn – 0.90Vn</p> <p>-</p> <p>2.2 Voltage set point 1.07Vn – 1.10Vn</p> <p>-</p>	N/A
3	Under/Over frequency protection (Topic No. 8.2).	In case that the frequency at the interconnection point is not between 47.00 Hz – 52.00 Hz, the converter system must disconnect from the power system within 100 ms.	<p>Maximum trip time :</p> <p>f < 47Hz = 0.061s</p> <p>f > 52Hz = 0.063s</p> <p>See APPENDIX C. page 93, 11. Over/Under frequency and page 165 – 166.</p>	Complied ⁽¹⁾



Compliance Evaluation Report



REPORT No.: CSSC/BOS/005

ISSUED DATE: March 9, 2023

Test Compliance Validation													
Technical Consideration Criteria			Submitted result - Remark	Compliance verdict / Technical comment									
4	Voltage Fluctuation (Topic No. 8.3).	<p>A connection requester must design, install, and regulate his equipment in the manner that will not cause voltage fluctuation at the point of common coupling (PCC) that is excess of the levels acceptable to PEA, as specified in the Voltage Fluctuation Regulation for Business and Industrial Customers shown in Attachment 3. The Voltage Fluctuation Regulation could be reviewed and re-considered from time to time.</p> <p>PRC/PGQ-02/1998. The limits for the utility voltage at PCC less than 115kV are as follow:</p> <p>Short-Term severity Values (Pst) not exceed 1.0 Long-Term severity Values (Plt) not exceed 0.8</p> <p style="text-align: center;">ตารางที่ 6-1 ขีดจำกัดสำหรับ ค่าความรุนแรงของไฟกะพริบระยะสั้น (Pst) และค่าความรุนแรงของไฟกะพริบระยะยาว (Plt) เมื่อรวมแหล่งกำเนิดแรงดันกระแสเพื่อทั้งหมดที่มีผลต่อระบบไฟฟ้า ณ จุดใดๆ</p> <table border="1" style="margin-left: auto; margin-right: auto;"> <thead> <tr> <th>ระดับแรงดันไฟฟ้า ที่จุดต่อร่วม</th> <th>Pst</th> <th>Plt</th> </tr> </thead> <tbody> <tr> <td>115 kV หรือต่ำกว่า</td> <td>1.0</td> <td>0.8</td> </tr> <tr> <td>มากกว่า 115 kV</td> <td>0.8</td> <td>0.6</td> </tr> </tbody> </table>	ระดับแรงดันไฟฟ้า ที่จุดต่อร่วม	Pst	Plt	115 kV หรือต่ำกว่า	1.0	0.8	มากกว่า 115 kV	0.8	0.6	<p>Test procedure referred to IEC 61000-3-11</p> <p>Pst (max) = 0.01 Plt (max) = 0.01</p> <p>See APPENDIX C. page 74, 4. Flicker</p>	Complied ⁽¹⁾
ระดับแรงดันไฟฟ้า ที่จุดต่อร่วม	Pst	Plt											
115 kV หรือต่ำกว่า	1.0	0.8											
มากกว่า 115 kV	0.8	0.6											



Compliance Evaluation Report



REPORT No.: CSSC/BOS/005

ISSUED DATE: March 9, 2023

Test Compliance Validation			
Technical Consideration Criteria		Submitted result - Remark	Compliance verdict / Technical comment
5	Harmonics (Topic No. 8.4).	<p>A connection requester must design, install, and control his equipment in the manner that will not cause frequency and current distortion at the point of common coupling (PCC) that is excess of the levels acceptable to PEA, as specified in the Harmonic Regulation for business and Industrial Customers shown in Attachment 4. The Harmonic Regulation may be reviewed from time to time.</p> <p>Test procedure referred to IEC61000-3-12 %THDi (max) = 1.91% %THDv (max) = 0.05% (at rated output power) 2nd – 33rd Current harmonics are in limit in accordance with IEC61727.</p>	Complied ⁽¹⁾



Compliance Evaluation Report



REPORT No.: CSSC/BOS/005

ISSUED DATE: March 9, 2023

Test Compliance Validation																																																																																																																																																																																																					
Technical Consideration Criteria		Submitted result - Remark	Compliance verdict / Technical comment																																																																																																																																																																																																		
5	Harmonics (Topic No. 8.4). (Cont.) <div style="text-align: center;"> <p>ตารางที่ 5-1</p> <p>ขีดจำกัดกระแสฮาร์มอนิกสำหรับผู้ใช้ไฟฟ้ารายใดที่จุดต่อร่วม *</p> <table border="1"> <thead> <tr> <th rowspan="2">ระดับแรงดันไฟฟ้าที่จุดต่อร่วม (kV)</th> <th colspan="19">อันดับฮาร์มอนิกและขีดจำกัดของกระแส (A rms)</th> </tr> <tr> <th>2</th><th>3</th><th>4</th><th>5</th><th>6</th><th>7</th><th>8</th><th>9</th><th>10</th><th>11</th><th>12</th><th>13</th><th>14</th><th>15</th><th>16</th><th>17</th><th>18</th><th>19</th> </tr> </thead> <tbody> <tr> <td>0.400</td> <td>48</td><td>34</td><td>22</td><td>56</td><td>11</td><td>40</td><td>9</td><td>8</td><td>7</td><td>19</td><td>6</td><td>16</td><td>5</td><td>5</td><td>5</td><td>6</td><td>4</td><td>6</td> </tr> <tr> <td>11 and 12</td> <td>13</td><td>8</td><td>6</td><td>10</td><td>4</td><td>8</td><td>3</td><td>3</td><td>3</td><td>7</td><td>2</td><td>6</td><td>2</td><td>2</td><td>2</td><td>1</td><td>1</td><td></td> </tr> <tr> <td>22 , 24 and 33</td> <td>11</td><td>7</td><td>5</td><td>9</td><td>4</td><td>6</td><td>3</td><td>2</td><td>2</td><td>6</td><td>2</td><td>5</td><td>2</td><td>1</td><td>1</td><td>2</td><td>1</td><td>1</td> </tr> <tr> <td>69</td> <td>8.8</td><td>5.9</td><td>4.3</td><td>7.3</td><td>3.3</td><td>4.9</td><td>2.3</td><td>1.6</td><td>1.6</td><td>4.9</td><td>1.6</td><td>4.3</td><td>1.6</td><td>1</td><td>1</td><td>1.6</td><td>1</td><td>1</td> </tr> <tr> <td>115 and above</td> <td>5</td><td>4</td><td>3</td><td>4</td><td>2</td><td>3</td><td>1</td><td>1</td><td>1</td><td>3</td><td>1</td><td>3</td><td>1</td><td>1</td><td>1</td><td>1</td><td>1</td><td>1</td> </tr> </tbody> </table> <p>ตารางที่ 5-2</p> <p>ขีดจำกัดความถี่ฮาร์มอนิกของแรงดันสำหรับผู้ใช้ไฟฟ้ารายใดที่จุดต่อร่วม (รวมทั้งระดับความถี่ที่มีอยู่เดิม)</p> <table border="1"> <thead> <tr> <th rowspan="2">ระดับแรงดันไฟฟ้าที่จุดต่อร่วม (kV)</th> <th rowspan="2">ค่าความถี่ฮาร์มอนิกรวมของแรงดัน (%)</th> <th colspan="2">ค่าความถี่ฮาร์มอนิกของแรงดันแต่ละอันดับ (%)</th> </tr> <tr> <th>อันดับที่</th> <th>อันดับอยู่</th> </tr> </thead> <tbody> <tr> <td>0.400</td> <td>5</td> <td>4</td> <td>2</td> </tr> <tr> <td>11 , 12 , 22 and 24</td> <td>4</td> <td>3</td> <td>1.75</td> </tr> <tr> <td>33</td> <td>3</td> <td>2</td> <td>1</td> </tr> <tr> <td>69</td> <td>2.45</td> <td>1.63</td> <td>0.82</td> </tr> <tr> <td>115 and above</td> <td>1.5</td> <td>1</td> <td>0.5</td> </tr> </tbody> </table> </div>	ระดับแรงดันไฟฟ้าที่จุดต่อร่วม (kV)	อันดับฮาร์มอนิกและขีดจำกัดของกระแส (A rms)																			2	3	4	5	6	7	8	9	10	11	12	13	14	15	16	17	18	19	0.400	48	34	22	56	11	40	9	8	7	19	6	16	5	5	5	6	4	6	11 and 12	13	8	6	10	4	8	3	3	3	7	2	6	2	2	2	1	1		22 , 24 and 33	11	7	5	9	4	6	3	2	2	6	2	5	2	1	1	2	1	1	69	8.8	5.9	4.3	7.3	3.3	4.9	2.3	1.6	1.6	4.9	1.6	4.3	1.6	1	1	1.6	1	1	115 and above	5	4	3	4	2	3	1	1	1	3	1	3	1	1	1	1	1	1	ระดับแรงดันไฟฟ้าที่จุดต่อร่วม (kV)	ค่าความถี่ฮาร์มอนิกรวมของแรงดัน (%)	ค่าความถี่ฮาร์มอนิกของแรงดันแต่ละอันดับ (%)		อันดับที่	อันดับอยู่	0.400	5	4	2	11 , 12 , 22 and 24	4	3	1.75	33	3	2	1	69	2.45	1.63	0.82	115 and above	1.5	1	0.5	Current harmonics results according to IEC61727:2004. <table border="1"> <thead> <tr> <th>Odd</th> <th>Limits (%)</th> <th>Maximum value (%)</th> </tr> </thead> <tbody> <tr> <td>3 – 9</td> <td>< 4.0</td> <td>order 3, 1.15</td> </tr> <tr> <td>11 – 15</td> <td>< 2.0</td> <td>order 11, 0.14</td> </tr> <tr> <td>17 – 21</td> <td>< 1.5</td> <td>order 17, 0.14</td> </tr> <tr> <td>23 – 33</td> <td>< 0.6</td> <td>order 23, 0.00</td> </tr> </tbody> </table> <table border="1"> <thead> <tr> <th>Even</th> <th>Limits (%)</th> <th>Maximum value (%)</th> </tr> </thead> <tbody> <tr> <td>2 – 8</td> <td>< 1.0</td> <td>order 2, 0.29</td> </tr> <tr> <td>10 – 32</td> <td>< 0.5</td> <td>order 10, 0.00</td> </tr> </tbody> </table> Voltage harmonics results. <table border="1"> <thead> <tr> <th>Odd</th> <th>Limits (%)</th> <th>Maximum value (%)</th> </tr> </thead> <tbody> <tr> <td>3 – 33</td> <td>< 4.0</td> <td>order 7, 0.03</td> </tr> </tbody> </table> <table border="1"> <thead> <tr> <th>Even</th> <th>Limits (%)</th> <th>Maximum value (%)</th> </tr> </thead> <tbody> <tr> <td>2 – 32</td> <td>< 2.0</td> <td>order 2, 0.01</td> </tr> </tbody> </table> See APPENDIX C. page 89 – 92, 10. Harmonic and waveform distortion	Odd	Limits (%)	Maximum value (%)	3 – 9	< 4.0	order 3, 1.15	11 – 15	< 2.0	order 11, 0.14	17 – 21	< 1.5	order 17, 0.14	23 – 33	< 0.6	order 23, 0.00	Even	Limits (%)	Maximum value (%)	2 – 8	< 1.0	order 2, 0.29	10 – 32	< 0.5	order 10, 0.00	Odd	Limits (%)	Maximum value (%)	3 – 33	< 4.0	order 7, 0.03	Even	Limits (%)	Maximum value (%)	2 – 32	< 2.0	order 2, 0.01
ระดับแรงดันไฟฟ้าที่จุดต่อร่วม (kV)	อันดับฮาร์มอนิกและขีดจำกัดของกระแส (A rms)																																																																																																																																																																																																				
	2	3	4	5	6	7	8	9	10	11	12	13	14	15	16	17	18	19																																																																																																																																																																																			
0.400	48	34	22	56	11	40	9	8	7	19	6	16	5	5	5	6	4	6																																																																																																																																																																																			
11 and 12	13	8	6	10	4	8	3	3	3	7	2	6	2	2	2	1	1																																																																																																																																																																																				
22 , 24 and 33	11	7	5	9	4	6	3	2	2	6	2	5	2	1	1	2	1	1																																																																																																																																																																																			
69	8.8	5.9	4.3	7.3	3.3	4.9	2.3	1.6	1.6	4.9	1.6	4.3	1.6	1	1	1.6	1	1																																																																																																																																																																																			
115 and above	5	4	3	4	2	3	1	1	1	3	1	3	1	1	1	1	1	1																																																																																																																																																																																			
ระดับแรงดันไฟฟ้าที่จุดต่อร่วม (kV)	ค่าความถี่ฮาร์มอนิกรวมของแรงดัน (%)	ค่าความถี่ฮาร์มอนิกของแรงดันแต่ละอันดับ (%)																																																																																																																																																																																																			
		อันดับที่	อันดับอยู่																																																																																																																																																																																																		
0.400	5	4	2																																																																																																																																																																																																		
11 , 12 , 22 and 24	4	3	1.75																																																																																																																																																																																																		
33	3	2	1																																																																																																																																																																																																		
69	2.45	1.63	0.82																																																																																																																																																																																																		
115 and above	1.5	1	0.5																																																																																																																																																																																																		
Odd	Limits (%)	Maximum value (%)																																																																																																																																																																																																			
3 – 9	< 4.0	order 3, 1.15																																																																																																																																																																																																			
11 – 15	< 2.0	order 11, 0.14																																																																																																																																																																																																			
17 – 21	< 1.5	order 17, 0.14																																																																																																																																																																																																			
23 – 33	< 0.6	order 23, 0.00																																																																																																																																																																																																			
Even	Limits (%)	Maximum value (%)																																																																																																																																																																																																			
2 – 8	< 1.0	order 2, 0.29																																																																																																																																																																																																			
10 – 32	< 0.5	order 10, 0.00																																																																																																																																																																																																			
Odd	Limits (%)	Maximum value (%)																																																																																																																																																																																																			
3 – 33	< 4.0	order 7, 0.03																																																																																																																																																																																																			
Even	Limits (%)	Maximum value (%)																																																																																																																																																																																																			
2 – 32	< 2.0	order 2, 0.01																																																																																																																																																																																																			



Compliance Evaluation Report



REPORT No.: CSSC/BOS/005

ISSUED DATE: March 9, 2023

Test Compliance Validation				
Technical Consideration Criteria			Submitted result - Remark	Compliance verdict / Technical comment
6	DC injection (Topic No. 8.5).	A connection requester possessing a converter system must design a protection system so that the direct current dispatched to the power network system at the interconnection point will not exceed 0.5% of the rated current of the converter.	Test procedure referred to IEEE1547.1-2005 clause 5.6 Maximum DC current injection is 0.001A (0.015 % of 6.8A) See APPENDIX C. page 75, 5. DC Injection and page 168.	Complied ⁽¹⁾



Compliance Evaluation Report



REPORT No.: CSSC/BOS/005

ISSUED DATE: March 9, 2023

Test Compliance Validation											
Technical Consideration Criteria			Submitted result - Remark	Compliance verdict / Technical comment							
7	Low voltage fault ride through (Topic No. 12.2).	<p>When encountering low voltage fault, a connection requester's generator must not immediately disconnect itself from its power network system and stay connected for a certain period of time. The voltage level at the interconnection point must be maintained as follows:</p> <p>The Period at which a Generator Must Stay Connected to Its Power Network System during a Temporary Low Voltage Fault</p> <table border="1"> <thead> <tr> <th>Voltage Level at the Connecting Point</th> <th>Time Duration (Second)</th> </tr> </thead> <tbody> <tr> <td>1) Low-voltage</td> <td>Not Required</td> </tr> <tr> <td>2) Medium or High Voltage (Generation Capacity \leq 500 kW)</td> <td rowspan="2">Required (see below graph)</td> </tr> <tr> <td>3) Medium to High Voltage (Generation Capacity $>$500 kW)</td> </tr> </tbody> </table>	Voltage Level at the Connecting Point	Time Duration (Second)	1) Low-voltage	Not Required	2) Medium or High Voltage (Generation Capacity \leq 500 kW)	Required (see below graph)	3) Medium to High Voltage (Generation Capacity $>$ 500 kW)	<p><u>Generation Capacity \leq 500 kW</u></p> <p>-</p>	N/A
			Voltage Level at the Connecting Point	Time Duration (Second)							
1) Low-voltage	Not Required										
2) Medium or High Voltage (Generation Capacity \leq 500 kW)	Required (see below graph)										
3) Medium to High Voltage (Generation Capacity $>$ 500 kW)											
			<p><u>Generation Capacity $>$ 500 kW</u></p> <p>-</p>	N/A							

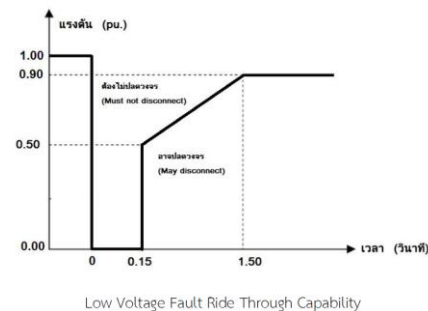



Compliance Evaluation Report



REPORT No.: CSSC/BOS/005

ISSUED DATE: March 9, 2023

Test Compliance Validation																
Technical Consideration Criteria			Submitted result - Remark	Compliance verdict / Technical comment												
8	Under/Over voltage protection (Topic No. 12.3).	<p>A connection requester's power generating system must be able to disconnect from its power network system if the level on Line to Neutral voltage is out of the specified level as detailed in the following table:</p> <p>The disconnecting period when encountering over or under voltage.</p> <table border="1"> <thead> <tr> <th>Voltage Level at the Connecting Point</th> <th>Disconnecting Period (Second)</th> </tr> </thead> <tbody> <tr> <td>$V < 50\%$</td> <td>0.3</td> </tr> <tr> <td>$50\% \leq V < 90\%$</td> <td>2.0</td> </tr> <tr> <td>$90\% \leq V \leq 110\%$</td> <td>Stay connected</td> </tr> <tr> <td>$110\% < V < 120\%$</td> <td>1.0</td> </tr> <tr> <td>$V \geq 120\%$</td> <td>0.16</td> </tr> </tbody> </table>	Voltage Level at the Connecting Point	Disconnecting Period (Second)	$V < 50\%$	0.3	$50\% \leq V < 90\%$	2.0	$90\% \leq V \leq 110\%$	Stay connected	$110\% < V < 120\%$	1.0	$V \geq 120\%$	0.16	<p>Maximum trip time:</p> <p>$V < 50\%$ = 0.270s</p> <p>$50\% \leq V < 90\%$ = 1.964s</p> <p>$110\% < V < 120\%$ = 0.128s</p> <p>$V \geq 120\%$ = 0.029s</p> <p>See APPENDIX C., page 87 – 88, 9. Over/Under voltage and page 157 - 164.</p>	Complied ⁽¹⁾
Voltage Level at the Connecting Point	Disconnecting Period (Second)															
$V < 50\%$	0.3															
$50\% \leq V < 90\%$	2.0															
$90\% \leq V \leq 110\%$	Stay connected															
$110\% < V < 120\%$	1.0															
$V \geq 120\%$	0.16															



Compliance Evaluation Report



REPORT No.: CSSC/BOS/005

ISSUED DATE: March 9, 2023

Test Compliance Validation			
Technical Consideration Criteria		Submitted result - Remark	Compliance verdict / Technical comment
9	Anti-Islanding (Topic No. 12.4).	To prevent islanding while there is no power supply at the power network system, a connection requester's generator must be capable to disconnect from the power network system within one second (1s).	<p>Test procedure referred to IEC62116 with voltage level 220V (phase to neutral voltage)</p> <p>Maximum run-on time:</p> <ol style="list-style-type: none"> Power 100% of rating, P_R +5%, Q_C 0% is 0.422s Power 66% of rating, P_R 0%, Q_C +2% is 0.368s Power 33% of rating, P_R 0%, Q_C +1% is 0.478s <p>See APPENDIX C., page 79 – 85, 7. Islanding Protection and page 95 – 144.</p>
			Complied ⁽¹⁾



Compliance Evaluation Report



REPORT No.: CSSC/BOS/005

ISSUED DATE: March 9, 2023

Test Compliance Validation				
Technical Consideration Criteria			Submitted result - Remark	Compliance verdict / Technical comment
10	Response to utility recovery (Topic No. 12.5).	After the disconnection, if the power network system resumes to its normal state, the connection requester's generator must be able to wait about 20 seconds to 5 minutes before re-connecting to the power network system.	Test procedure referred to IEEE1547.1-2005 Clause 5.10 Reconnecting time: $50\% < V < 90\% = 126.9s$ $110\% < V < 120\% = 127.9s$ and $f < 47Hz = 127.1s$ $f > 52Hz = 127.1s$ See APPENDIX C., page 86, 8. Response to Utility Recovery and page 145-156.	Complied ⁽¹⁾

(1) The test results/information from an accredited third-party laboratory and are submitted to CSSC by the manufacturer/applicant. Compliance comments are provided based on the submitted values and relevant details. Details of the accredited laboratory as APPENDIX D.



Compliance Evaluation Report



REPORT No.: CSSC/BOS/005

ISSUED DATE: March 9, 2023

APPENDIX A1. List of documents from the TÜV Rheinland (Shanghai) Co., Ltd.

TÜV Rheinland (Shanghai) Co., Ltd.
Member of TÜV Rheinland Group



Dear Whom it may concerns ,

For compliance test report evaluation, we herewith submit following documentations to CSSC:

1. Technical specification of product : Manual.pdf
2. Test report: CN23Y4BO 001 .pdf
3. Laboratory accreditation: CNAS L3038 certificate-EN.pdf
4. Table of compliance: Comply table .pdf
5. Documentation list: Confirmation letter.pdf

We appreciate your valued support and would like to offer any help and varied services in the future.

With kind regards,

TÜV Rheinland (Shanghai) Co., Ltd.

Allen Hu
Project Engineer
Solar & Commercial Products

TÜV Rheinland (Shanghai) Co., Ltd. 10-15/F, Huatsing Building, 上海市广中西路 777 弄 88 号 Tel.: (+86)21-61081188
莱茵技术(上海)有限公司 No. 88, Lane 777, 华清大厦 10-15 层 Fax: (+86) 21-6108 1199
West Guangzhong Road, 邮编: 200072 E-mail: info@shg.chn.tuv.com
200072 Shanghai, P.R. China Website: www.chn.tuv.com

QMA30.105.11SHG_7.1 Format of Notification of Test Result (Documentation incomplete)/ Revision date: 2008-05-14

This report is digitally signed only on the first page and does not need to be signed on all pages.



Compliance Evaluation Report



REPORT No.: CSSC/BOS/005

ISSUED DATE: March 9, 2023

APPENDIX A2. PEA Grid Code Compliance Table.



SolaX Power Network Technology (ZheJiang) Co., Ltd.

PEA Grid code compliance table

Item	Description	PEA requirement	Test results /Comment	Refer to Test report(or document)/ page	Complied/ Does not comply
1	Voltage and Frequency	High voltage :115kV and 69kV Medium voltage:33kV and 22kV Low voltage: 220V, 1 phase. 380V, 3 phase Frequency: 50Hz	Rated voltage:220/230/240V, Rated frequency: 50/60Hz The product only applied to the low voltage level grid.	Refer to the name plate of product in report CN23Y4BO 001 / Page 4.	Complied
2	Harmonics	Refer to IEC	Total harmonic distortion:%THD (max) =1.91% Current harmonics are in the limit according to IEC61727	Refer to Test report CN23Y4BO 001 /Page 25-28	Complied
3	Voltage fluctuation	Refer to IEC	Pst value: Pst(max)= 0.01 Plt value: Plt(max)= 0.01	Refer to Test report CN23Y4BO 001 /Page 10	Complied
4	DC injection	Not more than 0.5% of inverter rating current	DC injection value (max): 0.001A of 6.818A= 0.015% of rated current	Refer to Test report CN23Y4BO 001 /Page 11 and 104	Complied
5	Reactive power control	Installation Power More than 500kW 0.9 Lag to 0.9 Lead 1) Fixed displacement factor 2) Variable reactive power depend on voltage	Installation power less than 500kW : fixed displacement factor(max): Lagging: 0.95, Leading: 0.95	Refer to Test report CN23Y4BO 001 /Page 12-14	Complied

This report is digitally signed only on the first page and does not need to be signed on all pages.



Compliance Evaluation Report



REPORT No.: CSSC/BOS/005

ISSUED DATE: March 9, 2023

APPENDIX A2. PEA Grid Code Compliance Table. (Cont.)

Item	Description	PEA requirement	Test results /Comment	Refer to Test report(or document) page	Complied/ Does not comply
6	Active Power control	Adjustable power 10% each step from 100-0%	Adjustable power 10% each step from 100-0% results within 10min.	Refer to Test report CN23Y4BO 001 /Page 30 and 105	Complied
7	Low voltage fault Ride through	Installation Power More than 500kW. Capability with PEA wave form	Less than 500kW, no requirements.	Not applicable	Not applicable
8	Under and Over voltage protection	Disconnect time of PEA requirement $V < 50\%$ = 0.3 Sec $50\% < V < 90\%$ = 2.0 Sec $110\% < V < 120\%$ = 1.0 Sec $V > 120$ = 0.16 Sec	Under and Over voltage trip time value (max): $V < 50\%$ = 0.2698 Sec $50\% < V < 90\%$ = 1.9644 Sec $110\% < V < 120\%$ = 0.1275 Sec $V > 120$ = 0.0287 Sec	Refer to Test report CN23Y4BO 001 /Page 23-24 and 93-102	Complied
9	Under and Over frequency protection	Disconnect time of PEA requirement $f < 47$ Hz = 0.1 Sec $f > 52$ Hz = 0.1 Sec	Under and Over frequency trip time value (max): $f < 48$ Hz = 0.0607 Sec $f > 51$ Hz = 0.0627 Sec	Refer to Test report CN23Y4BO 001 /Page 29 and 101-102	Complied
10	Anti-Islanding	Disconnect time of PEA requirement = 1 Sec Max	Trip time value (max): $P_{EUT}100\%$, $P_R0\%$, $Q_C0\%$, = 0.302 Sec $P_{EUT}66\%$, $P_R0\%$, $Q_C0\%$, = 0.348 Sec $P_{EUT}33\%$, $P_R0\%$, $Q_C0\%$, = 0.342 Sec	Refer to Test report CN23Y4BO 001 /Page 15-21 and 28-77	Complied

This report is digitally signed only on the first page and does not need to be signed on all pages.



Compliance Evaluation Report



REPORT No.: CSSC/BOS/005

ISSUED DATE: March 9, 2023

APPENDIX A2. PEA Grid Code Compliance Table. (Cont.)

Item	Description	PEA requirement	Test results / Comment	Refer to Test report (or document) / page	Complied / Does not comply
11	Reconnection to utility recovery	Reconnection time of PEA requirement = 20s to 5 mins	Reconnection time value: After back to specified recovery voltage range V = 90% =126.9 Sec V = 110% =127.9 Sec After back to specified frequency voltage range f = 48.0Hz =127.1 Sec f = 51.0Hz =127.1 Sec	Refer to Test report CN23Y4BO 001 /Page 22 and 81-92	Complied

Allen Hu



Compliance Evaluation Report



REPORT No.: CSSC/BOS/005

ISSUED DATE: March 9, 2023

APPENDIX B. X1 Series User Manual 0.6kW - 3.3kW.

REV.	Description	REV.	Description
0.0	首次发行 会推序 2022/7/27		

技术要求:

- 1.封面材质157g铜版纸覆膜印刷，内附880g双胶纸黑白印刷，正反打印
- 2.装订方式:资料大于60页需挂胶装
- 3.装订尺寸公差:±1.5mm
- 4.圆角:字体与图形清晰、无毛边、不起边、油墨不脱落
- 5.字体颜色为PANTONE Black C, 无过色，颜色为白色
- 6.符合GB/T 5882

品名	挂图式手册 X1-MIN G4 英文 50xX	设计	余祖华	2022/7/27
材料	NA	审核	陈高亮	2022/7/27
料号	320101046700	标注	陈高亮	2022/7/27
单位	mm 页次	浙江艾罗能源科技股份有限公司		

品名	挂图式手册 X1-MIN G4 英文 50xX	设计	余祖华	2022/7/27
材料	NA	审核	陈高亮	2022/7/27
料号	320101046700	标注	陈高亮	2022/7/27
单位	mm 页次	浙江艾罗能源科技股份有限公司		



Compliance Evaluation Report



REPORT No.: CSSC/BOS/005

ISSUED DATE: March 9, 2023

APPENDIX B. X1 Series User Manual 0.6kW - 3.3kW. (Cont.)



Solax Power Network Technology(Zhejiang) Co., Ltd.

No.288 Shizhu Road, Tonglu Economic Development Zone, Tonglu City, Zhejiang Province, China.
Tel: +86 0571-56260011
E-mail: info@solaxpower.com

EN

Copyright Declaration
The copyright of this manual belongs to Solax Power Network Technology(Zhejiang) Co., Ltd.
Any corporation or individual should not plagiarize, partially or fully copy (including software, etc.), and no replication or distribution of it in any form or by any means. All rights reserved. Solax Power Network Technology (Zhejiang) Co., Ltd. reserves the right of final interpretation.

320101046700

www.solaxpower.com

This report is digitally signed only on the first page and does not need to be signed on all pages.



Compliance Evaluation Report



REPORT No.: CSSC/BOS/005

ISSUED DATE: March 9, 2023

APPENDIX B. X1 Series User Manual 0.6kW - 3.3kW. (Cont.)

Contents

Contents	
1 Note on this Manual	03
1.1 Scope of Validity.....	03
1.2 Target Group.....	03
1.3 Symbols Used.....	03
2 Safety	04
2.1 Appropriate Usage.....	04
2.2 Important Safety Instructions.....	06
2.3 PE Connection and Leakage Current.....	08
2.4 Explanation of Symbols.....	09
2.5 EC Directives.....	10
3 Introduction	11
3.1 Basic Features	11
3.2 Terminals of the Inverter	12
3.3 Dimension	13
4 Technical Data	14
4.1 DC Input.....	14
4.2 AC Output	14
4.3 Efficiency, Safety and Protection.....	15
4.4 General Data.....	15
5 Installation	16
5.1 Check for Transport Damage.....	16
5.2 Packing Lists	16
5.3 Installation Precaution.....	17
5.4 Installation Steps.....	20
5.5 Connections of the Inverter.....	23
5.6 Run the Inverter.....	44
6 Operation Method	48
6.1 Control Panel	48
6.2 LCD Structure	49
6.3 LCD Operation	50

01



Compliance Evaluation Report



REPORT No.: CSSC/BOS/005

ISSUED DATE: March 9, 2023

APPENDIX B. X1 Series User Manual 0.6kW - 3.3kW. (Cont.)

Contents

7 Troubleshooting	75
7.1 Troubleshooting	75
7.2 Routine Maintenance.....	78
8 Decommissioning	79
8.1 Dismantling the Inverter.....	79
8.2 Packaging	79
8.3 Storage and Transportation	79
9 Disclaimer	80
* Warranty registration form	

Notes on this Manual

1.1 Scope of Validity

1 Notes on this Manual

This manual is an integral part of X1 Series. It describes the assembly, installation, commissioning, maintenance and failure of the product. Please read it carefully before operating.

X1-MINI-0.6K-G4	X1-MINI-0.7K-G4	X1-MINI-1.1K-G4	X1-MINI-1.5K-G4
X1-MINI-2.0K-G4	X1-MINI-2.5K-G4	X1-MINI-3.0K-G4	X1-MINI-3.3K-G4

Note: "X1" means single phase; "MINI" means MINI series; "K" means kW; "G4" means 4th generation. Keep this manual at where is accessible all the time.

1.2 Target Group

1.3 Symbols Used

This manual is for qualified electricians. The tasks described in this manual can only be performed by qualified electricians.

The following types of safety instructions and general information appear in this document as described below:

	DANGER! "Danger" indicates a hazardous situation which, if not avoided, will result in death or serious injury.
	WARNING! "Warning" indicates a hazardous situation which, if not avoided, could result in death or serious injury.
	CAUTION! "Caution" indicates a hazardous situation which, if not avoided, could result in minor or moderate injury.
	NOTE! "Note" provides tips that are valuable for the optimal operation of your product.



APPENDIX B. X1 Series User Manual 0.6kW - 3.3kW. (Cont.)

Safety

2 Safety

2.1 Appropriate Usage

This series inverter are PV inverters which can convert the DC current of the PV generator into AC current and feed it into the public grid.

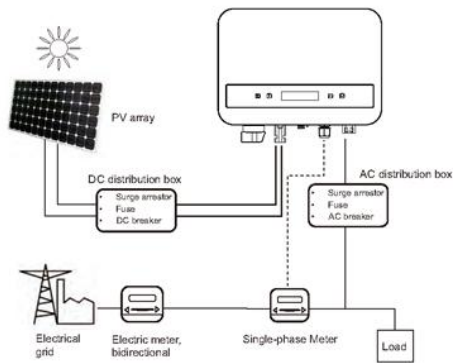

04

Safety

Lightning will cause a damage either from a direct strike or from surges due to a nearby strike.

Induced surges are the most likely cause of lightning damage in most situations or installations, especially in rural areas where electricity is usually provided by long overhead lines. Surge may be included on both the PV array conduction and the AC cables leading to the building.

Specialists in lightning protection should be consulted during the end use application. Using appropriate external lightning protection, the effect of a direct lightning strike into a building can be mitigated in a controlled way, and the lightning current can be discharged into the ground.

All DC cables should be installed to as short as possible, and positive and negative cables of the string or main DC supply should be bundled together. Avoid creating loops in the system. This requirement for short runs and bundling includes any associated earth bundling conductors.

Spark gap devices are not suitable to be used in DC circuits once conducting, they won't stop conducting until the voltage passes through their terminals typically less than 30 volts.

> Anti-Islanding Effect

Islanding effect is a special phenomenon that grid-connected PV system still supply power to the nearby grid when the voltage loss is happened in the power system. It is dangerous for maintenance personnel and the public.

This series inverter provides Active Frequency Drift (AFD) to prevent islanding effect.

05



Compliance Evaluation Report



REPORT No.: CSSC/BOS/005

ISSUED DATE: March 9, 2023

APPENDIX B. X1 Series User Manual 0.6kW - 3.3kW. (Cont.)

Safety

Safety

2.2 Important Safety Instructions

DANGER!

- Danger to life due to high voltages in the inverter!
- All work must be carried out by qualified electrician.
- The appliance is not to be used by children or persons with reduced physical sensory or mental capabilities, or lack of experience and knowledge, unless they have been given supervision or instruction.
- Children should be supervised to ensure that they do not play with the appliance.

CAUTION!

Danger of burn injuries due to hot enclosure parts!

- During operation, the upper lid of the enclosure and the enclosure body may become hot.
- Only qualified electrician can touch the lower enclosure lid during operation.

CAUTION!

Possible damage to health as a result of the effects of radiation!

Pregnant women and children should not stay close to the inverter.

NOTE!

Grounding the PV generator!

Comply with the local requirements for grounding the PV modules and the PV generator. We recommend connecting the generator frame and other electrically conductive surfaces in a manner which ensures continuous conduction and ground these in order to have optimal protection of system and persons.

WARNING!

- Ensure input DC voltage \leq Max. DC voltage. Over voltage may cause permanent damage to inverter or other losses, which will not be included in warranty!

WARNING!

Risk of electric shock!

WARNING!

- Authorized service personnel must disconnect both AC and DC power from the inverter before attempting any maintenance or cleaning or working on any circuits connected to the inverter.

- Prior to the application, please read this section carefully to ensure correct and safe application. Please keep the user manual properly.
- Use only recommended attachments. Otherwise may result in a risk of fire, electric shock, or injury to person.
- Make sure that existing wiring is in good condition and that wire is not undersized.
- Do not disassemble any parts of inverter which are not mentioned in installation guide. It contains no user-serviceable parts. See Warranty for instructions on obtaining service. Attempting to service the inverter yourself may result in a risk of electric shock or fire and will void your warranty.
- Keep away from flammable, explosive materials to avoid fire disaster.
- The installation place should be away from humid or corrosive substance.
- Authorized service personnel must use insulated tools when installing or working with this equipment.
- PV modules shall have an IEC 61730 class A rating.
- Avoid touching the PV connecting device in case of electric shock.
- After the MAINS and PV supply has been disconnected, the capacitor of the unit still contains hazardous voltage for up to 5 minutes, please don't touch during this period.
- Hazardous voltage will present for up to 5 minutes after disconnection from power supply.
- CAUTION-RISK of electric shock from energy stored in capacitor. Never operate on the solar inverter couplers, the MAINS cables, PV cables or the PV generator when power is applied. After switching off the PV and Mains, always wait for 5 minutes to let the intermediate circuit capacitors discharge before you unplug DC and MAINS couplers.
- When accessing the internal circuit of solar inverter, it is very important to wait 5 minutes before operating the power circuit or demounting the electrolyte capacitors inside the device. Do not open the device beforehand since the capacitors require time to sufficiently discharge!
- Measure the voltage between terminals UDC+ and UDC- with a multi-meter (impedance at least 1 Mohm) to ensure that the device has totally discharged.

06

07



Compliance Evaluation Report



REPORT No.: CSSC/BOS/005

ISSUED DATE: March 9, 2023

APPENDIX B. X1 Series User Manual 0.6kW - 3.3kW. (Cont.)

Safety

- 2.3 PE Connection and Leakage Current
- The inverter incorporates a certified internal Residual Current Device (RCD) in order to protect against possible electrocution and fire hazard in case of a malfunction in the cables or the inverter. There are two trip thresholds for the RCD as required for certification (IEC 62109-2: 2011). The default value for electrocution protection is 30 mA, and for slow rising current is 300 mA.
- If an external RCD is required by local regulations, check which type of RCD is required for relevant electric code. It recommends using a type-A RCD. The recommended RCD values is 300 mA unless a lower value is required by the specific local electric codes.

The device is intended to connect to a PV generator with a capacitance limit of approx 700 nf.

WARNING!

- High leakage current!
- Earth connection is essential before connecting power supply.

08

Safety

2.4 Explanation of Symbols

• Symbols on the Inverter

This section gives an explanation of all the symbols shown on the inverter and on the type label.

Symbol	Explanation
	When the blue light is on, it indicates the inverter is working normally.
	When the red light is on, it indicates an error has occurred.

• Symbols on the Type Label

Symbol	Explanation
	CE mark. The inverter complies with the requirements of the applicable CE guidelines.
	Compliant with UKCA standards.
	RCM remark.
	TUV certification.
	Beware of hot surface. The inverter can become hot during operation. Avoid contact during operation.
	Danger of high voltages. Danger to life due to high voltages in the inverter!
	Danger. Risk of electric shock!
	Observe enclosed documentation.
	The inverter can not be disposed together with the household waste. Disposal information can be found in the enclosed documentation.
	Do not operate this inverter until it is isolated from mains and on-site PV generation suppliers.
	Danger to life due to high voltage. There is residual voltage in the inverter which needs 5 min to discharge. <ul style="list-style-type: none"> Wait 5 min before you open the upper lid or the DC lid.

09



Compliance Evaluation Report



REPORT No.: CSSC/BOS/005

ISSUED DATE: March 9, 2023

APPENDIX B. X1 Series User Manual 0.6kW - 3.3kW. (Cont.)

Safety

2.4 CE Directives

This section describes the requirements of the European low voltage regulations, including safety instructions and system licensing conditions, the user must comply with these regulations when installing, operating, and maintaining the inverter, otherwise personal injury or death may occur, and the inverter will be damaged.

Please read the manual carefully when operating the inverter. If you do not understand "Danger", "Warning", "Caution" and the description in the manual, please contact the manufacturer or service agent before installing and operating the inverter.

Make sure that the whole system complies with the requirements of EC (2014/35/EU, 2014/30/EU, etc.) before starting the module (i.e. to start the operation).

Standard of 2014/35/EU (LVD)
EN IEC 62109-1; EN IEC 62109-2
EN 62477-1

Standard of 2014/30/EU (EMC)
EN IEC 61000-6-1; EN IEC 61000-6-2;
EN IEC 61000-6-3; EN IEC 61000-6-4;
EN IEC 61000-3-2; EN 61000-3-3;
EN IEC 61000-3-11; EN 61000-3-12
EN 55011

The assembly shall be installed in accordance with the statutory wiring rules. Install and configure the system in accordance with safety rules, including the use of specified wiring methods. The installation of the system can only be done by professional assemblers who are familiar with safety requirements and EMC. The assembler shall ensure that the system complies with the relevant national laws. The individual subassembly of the system shall be interconnected by means of the wiring methods outlined in national/international such as the national electric code (NFPA) No. 70 or VDE regulation 4105.

10

Introduction

3 Introduction

3.1 Basic Features

Thanks for purchasing our inverter. The inverter incorporates advanced technology, high reliability, and convenient control features.

- Advanced DSP control technology.
- Utilize the latest high-efficiency power component.
- Optimal MPPT technology.
- One MPP Tracking.
- Wide MPPT input range.
- Advanced anti-islanding solutions.
- Class I protection level.
- Max. efficiency up to 98%. EU efficiency up to 96.5%.
- THD<3%.

11



APPENDIX B. X1 Series User Manual 0.6kW - 3.3kW. (Cont.)

Introduction

3.2 Terminals of the Inverter

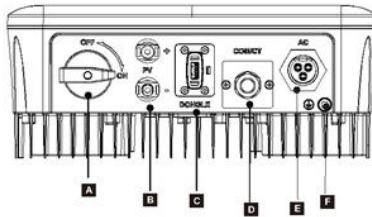

Object	Description
A	DC switch
B	DC input terminal
C	Dongle
D	COM/CT
E	AC output terminal
F	Ground terminal

Note: CT and meter is optional. If necessary, please consult us in detail.

WARNING!
Only authorized personnel are allowed to set the connection.

12

Introduction

3.3 Dimension

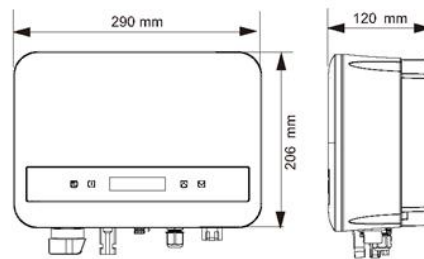

13



Compliance Evaluation Report



REPORT No.: CSSC/BOS/005

ISSUED DATE: March 9, 2023

APPENDIX B. X1 Series User Manual 0.6kW - 3.3kW. (Cont.)

Technical Data

4. Technical Data

4.1 DC Input

Model	X1-MINI 0.6K-G4	X1-MINI 0.7K-G4	X1-MINI 1.1K-G4	X1-MINI 1.5K-G4	X1-MINI 2.0K-G4	X1-MINI 2.5K-G4	X1-MINI 3.0K-G4	X1-MINI 3.3K-G4
Max. PV array input power [W]	1200	1400	2200	3000	4000	5000	6000	6600
Max. PV input voltage [V]	450	450	450	450	450	550	550	550
Startup voltage [V]	50	50	50	50	50	50	50	50
Nominal input voltage [V]	280	280	280	380	380	380	380	380
MPP tracker voltage range [V]	40-450	40-450	40-450	40-450	40-450	40-550	40-550	40-550
No. of MPP trackers/Strings per MPP Tracker	1:1							
Max. input current [A]	16 A							
Max. short circuit current [A]	22 A							

4.2 AC Output

Model	X1-MINI 0.6K-G4	X1-MINI 0.7K-G4	X1-MINI 1.1K-G4	X1-MINI 1.5K-G4	X1-MINI 2.0K-G4	X1-MINI 2.5K-G4	X1-MINI 3.0K-G4	X1-MINI 3.3K-G4
Nominal AC output power [W]	600	700	1100	1500	2000	2500	3000	3300
Nominal AC output current [A]	2.6	3.1	4.8	6.5	8.7	10.8	13.1	14.4
Max. AC output apparent power [VA]	600	710	1210	1650	2200	2750	3300	3500
Max. AC output current [A]	3	3.5	5.5	7.5	10	12.5	15	15
Nominal AC voltage [V]	220/230/240							
Nominal grid frequency [Hz]	50/60							
Displacement power factor	0.8 leading-0.8 lagging							
THD (rated power) [%]	<3							

14

Technical Data

4.3 System Data, Protection and Standard

Model	X1-MINI 0.6K-G4	X1-MINI 0.7K-G4	X1-MINI 1.1K-G4	X1-MINI 1.5K-G4	X1-MINI 2.0K-G4	X1-MINI 2.5K-G4	X1-MINI 3.0K-G4	X1-MINI 3.3K-G4
Max. efficiency [%]	98	98	98	98	98	98	98	98
Euro. efficiency [%]	95	95	95.5	96	96.5	96.5	96.5	96.5
Standby consumption [W] (EN50462)	<1							
Ingress protection	IP66							
Protection class	Class1							
Over voltage category	II (DC), III (AC)							
Operating temperature range [°C]	-25-60							
Max. operation altitude [m]	≤4000							
Humidity [%]	0-100							
Typical noise emission [dB]	25							
Storage temperature [°C]	-20-70							
Dimensions(W×H×D) [mm]	290x200x120							
Weight [kg]	5.2	5.2	5.2	5.2	5.2	5.5	5.5	5.5
Cooling concept	Natural cooling							
Communication interface	WiFi/LAN/G Dongle (optional) RS485/RS485CT/EX/GD							
Protection								
Over/under voltage protection	YES							
DC isolation protection	YES							
Monitoring ground fault protection	YES							
Grid monitoring	YES							
DC injection monitoring	YES							
Back feed current monitoring	YES							
Residual current detection	YES							
Anti-islanding protection	YES							
Over temperature protection	YES							
SPD (PVA/C)	Type 3 (Optional)							
AFI	Optional							
Standard								
Safety	EN/IEC62109-1/2							
EMC	EN/IEC61000-6-1/2/3/4, EN/IEC61000-3-2/3/1/12, EN/IEC61011							
Certification	IEC61727, EN50549, GSR, AS 4777.2, VDE4105, CEI I-21, VFR							

15



APPENDIX B. X1 Series User Manual 0.6kW - 3.3kW. (Cont.)

Installation

5. Installation

5.1 Check for Transport Damage

Make sure the inverter is intact during transportation. If there are some visible damages, such as cracks, please contact your dealer immediately.

5.2 Packing Lists

Open the package and fetch out the product, check the accessories at first. The packing list is shown as below.

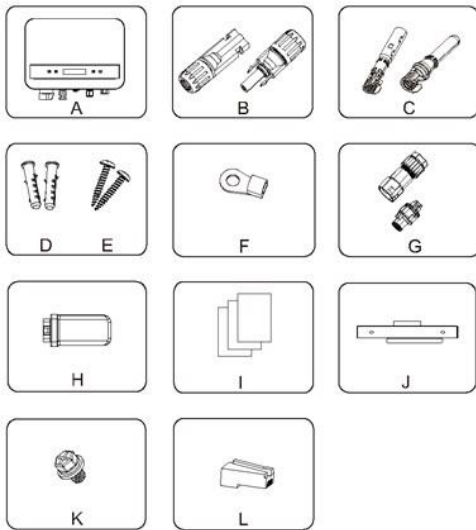

16

Installation

Object	Quantity	Description
A	1	Inverter
B	2	Female DC unit *1, Male DC unit *1
C	2	DC pin contact positive *1 DC pin contact negative *1
D	2	Expansion tube
E	2	Self-tapping screw
F	1	Earth terminal
G	1	AC connector
H	1	Dongle (optional)
I	/	Documentation
J	1	Bracket
K	1	M5*L8 screw
L	1	RJ45 terminal



NOTE!

For the optional accessories, please be subject to the actual delivery.

17



APPENDIX B. X1 Series User Manual 0.6kW - 3.3kW. (Cont.)

Installation

5.3 Installation Precaution

The inverter is designed for outdoor installation (IP 66).

Make sure the installation site meets the following conditions:

- Avoid exposure to glare.
- Avoid placing in areas where highly flammable materials are stored.
- Avoid placing in potential explosive areas.
- Avoid placing near the television antenna or antenna cable.
- Avoid placing in an altitude of higher than 4000 m above sea level.
- Avoid placing in environment of precipitation or humidity (100%).
- Be sure the ventilation is good enough.
- The ambient temperature in the range of -30°C to +70°C.
- The slope of the wall should be within ±5°.
- The wall hanging the inverter should meet conditions below:
 - 1) Solid brick/concrete, or strength equivalent mounting surface;
 - 2) Inverter must be supported or strengthened if the wall's strength isn't enough (such as wooden wall, the wall covered by thick layer of decoration)

Please avoid direct sunlight, rain exposure, snow laying up during installing and operating.



18

Installation

Available Space Size

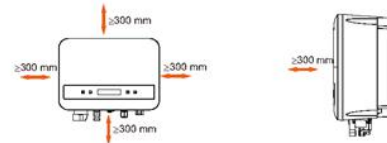

Table2 Available Space Size

Position	Min.size
Left	300 mm
Right	300 mm
Top	300 mm
Bottom	300 mm
Front	300 mm

NOTE!
Avoid installing in the confined space!

19



APPENDIX B. X1 Series User Manual 0.6kW - 3.3kW. (Cont.)

Installation

5.4 Installation Steps

➤ Preparation

Tools below are needed before installation.



➤ Step 1: Screw the wall bracket on the wall

a) Use the wall bracket as a template to mark the position of the 2 holes on the wall.

20

Installation

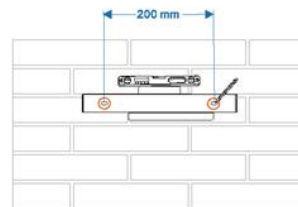

b) Drill holes with the drill (hole diameter: 6mm), make sure the holes are deep enough (at least 50 mm) for installation.

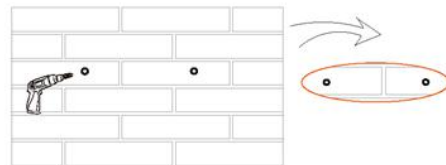

c) Insert the expansion tubes in the holes using the mallet, place the wall bracket and use self-tapping screws to tighten the bracket.

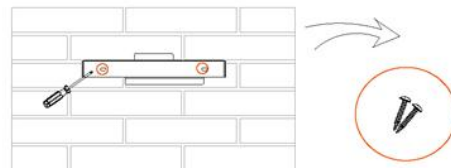

21



APPENDIX B. X1 Series User Manual 0.6kW - 3.3kW. (Cont.)

Installation

- > Step 2: Match the inverter with wall bracket
- d) Hang the inverter over the bracket, move the inverter close to it, slightly lay down the inverter, and make sure the mounting bar on the back are fixed well with the groove on the bracket.

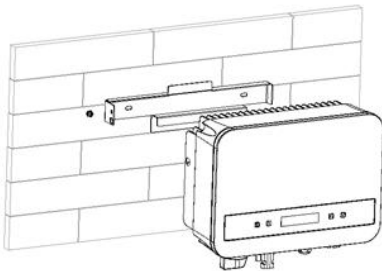

- e) Screw down the M5*L8 screw on the left side of the inverter.

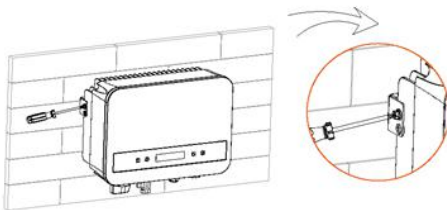

22

Installation

5.5 Connections of the Inverter

5.5.1 The Main Steps to Connect to the Inverter

> PV String Connection

The inverter has one-string PV connector. Please select PV modules with excellent function and reliable quality. Open circuit voltage of module array connected should be < Max. DC (table as follows) input voltage, and operating voltage should be within the MPPT voltage range.

Table3 Max. DC Voltage Limitation

Model	X1-MINI-0.6K/0.7K/1.1K/1.5K/2.0K-G4	X1-MINI-2.5/3.0/3.3K-G4
Max DC Voltage (V)	450	550

DANGER!
Danger to life due to high voltages on DC conductors.

- When exposed to sunlight, the PV array generates dangerous DC voltage which is present in the DC conductors. Touching the DC conductors can lead to lethal electric shocks.
- Cover the PV modules.
- Do not touch the DC conductors.

WARNING!
PV module voltage is very high which belongs to dangerous voltage range, please comply with the electric safety rules when connecting.

WARNING!
Please do not ground the PV positive or negative!

! Please follow the requirements of PV modules as below:

- Same type; Same quantity; Identical alignment; Identical tilt.
- In order to save cable and reduce the DC loss, we suggest installing the inverter near PV modules.

23



APPENDIX B. X1 Series User Manual 0.6kW - 3.3kW. (Cont.)

Installation

Installation

Table 4 Cable and Micro-breaker recommended

Model	X1-MNI-0.6K-G4	X1-MNI-0.7K-G4	X1-MNI-1.1K-G4	X1-MNI-1.5K-G4	X1-MNI-2.0K-G4	X1-MNI-2.5K-G4	X1-MNI-3.0K-G4	X1-MNI-3.3K-G4
L,N cable	2.5-6 mm ²	2.5-6 mm ²	2.5-6 mm ²	2.5-6 mm ²	2.5-6 mm ²	2.5-6 mm ²	2.5-6 mm ²	2.5-6 mm ²
PE cable	2.5-6 mm ²	2.5-6 mm ²	2.5-6 mm ²	2.5-6 mm ²	2.5-6 mm ²	2.5-6 mm ²	2.5-6 mm ²	2.5-6 mm ²
Micro-breaker	10 A	10 A	10 A	10 A	16 A	20 A	20 A	20 A

*Copper cable is recommended, if you use aluminum cable, please consult the inverter manufacturer.
 *The parameter varies because of different environment and material. Please choose appropriate cable and micro-breaker according to the local laws and regulations.

• Connection Steps

Tools below are needed before connection.



Wire stripper crimping tool



MC4 crimping tool (4mm² - 6mm²)

MC4 crimping tool recommended model: H4TC0001 manufacturer: Amphenol

- Turn off the DC switch, then choose 4mm² wire to connect the PV module.
- Strip 7mm of insulation from the wire end by using the wire stripper crimping tool.



Wire stripper crimping tool



- Insert striped wire into pin contact and ensure all conductor strands are captured in the pin contact.

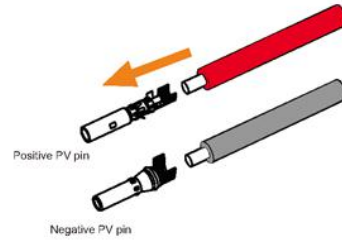

Positive PV pin

Negative PV pin

- Crimp pin contact by using the MC4 crimping tool.

MC4 crimping tool (4mm² - 6mm²)



(recommended model: H4TC0001, manufacturer: Amphenol)

Crimp these parts

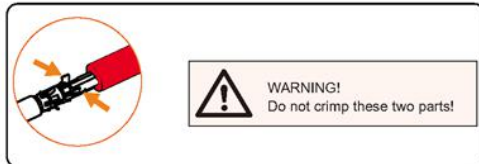



APPENDIX B. X1 Series User Manual 0.6kW - 3.3kW. (Cont.)

Installation

e) Separate the DC connector as two parts: the plug and the cable nut. Insert the wire into plug forcibly, when a "click" is heard or felt, the pin contact assembly is seated correctly.

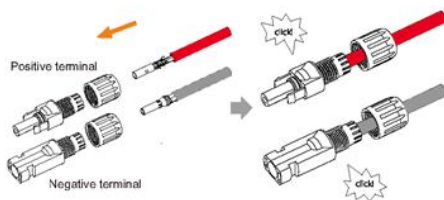

f) Then screw down the cable nut.

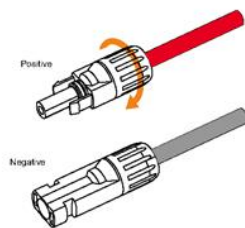

g) Use a multimeter to measure the open circuit voltage of the positive pole and negative pole of the PV cable, and make sure the open circuit voltage less than the permissive max input voltage;

26

Installation

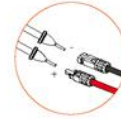
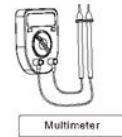

h) Remove the blue protective cover of the PV +&- interface at the bottom of the inverter, and insert the completed PV terminals according to the positive and negative correspondence.

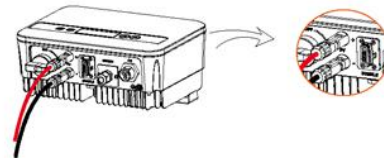

NOTE!
Keep the DC switch of the inverter OFF during connection.

27



APPENDIX B. X1 Series User Manual 0.6kW - 3.3kW. (Cont.)

Installation

> Grid Connection

The inverter is designed for single phase grid. Voltage range is 220/230/ 240 V, frequency is 50/ 60 Hz. Other technical requests should comply with the requirement of the local public grid.

NOTE!
Inverters should not be used in multiple phase combinations.

Micro-breaker should be installed between inverter and grid, any loads should not be connected with inverter directly.



Incorrect Connection between Load and Inverter

Impedance of the Inverter AC connecting dot should be less than 2 Ω. To ensure reliable anti-islanding function, PV cable should be used to ensure wire loss < 1% than normal power. Moreover, length between AC side and grid connecting dot should be less than 150 m. The following chart is the cable length, section area and wire loss.

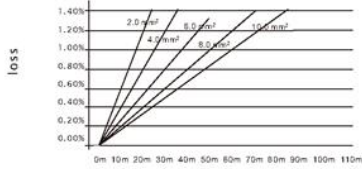

This product has a professional IP67 AC waterproof connector (after connection). You have to wire AC by yourself. Please see the figure above.

28

Installation

• Connection Steps

- a) Check the grid voltage and compare with the permissive voltage range (refer to technical data).
- b) Disconnect the circuit-breaker from all the phases and secure against re-connection.
- c) Strip the wires:
 - Strip L and N wires to 52.5mm and the PE wire to 55mm.
 - Use the crimping pliers to strip 6mm of insulation from all wire ends as below.

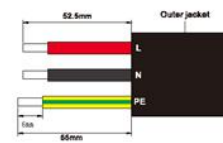

d) The AC connector provided in the packing list includes 2 parts (A and B).



- Separate A into 2 components.



- Then the AC connector is finally classified into 3 components for use (as shown below).



29



APPENDIX B. X1 Series User Manual 0.6kW - 3.3kW. (Cont.)

Installation

e) Slide the component 1 and component 2 onto the cable.



f) Insert the stripped end of each three wires into the appropriate hole in the component 3, and then tight each screw (to tight each wire in place). (Allen wrench. Torque: $0.5 \pm 0.1 \text{ N} \cdot \text{m}$)

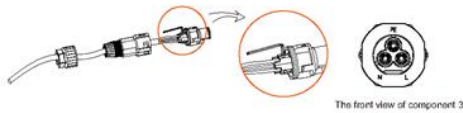

The front view of component 3

g) Insert component 3 into component 2.

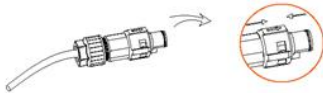

h) Screw down the component 1 tightly. (torque: $3 \pm 0.3 \text{ N} \cdot \text{m}$)



30

Installation

l) Connect the AC plug to the inverter.



> Earth Connection

Screw the ground screw with cross screwdriver shown as follow. (torque: $1.5 \pm 0.2 \text{ N} \cdot \text{m}$)

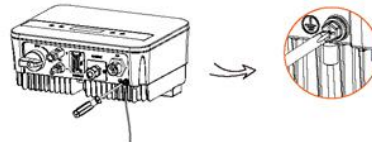

WARNING!
Be sure the ground wire must be connected!

31



APPENDIX B. X1 Series User Manual 0.6kW - 3.3kW. (Cont.)

Installation

Connection steps:

1) Use a crimping tool to strip the terminal from the PE cable.

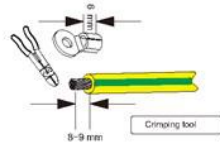

2) Slide the heat-shrink tubing (UI224 125°C VW-1 600V) over the PE cable.

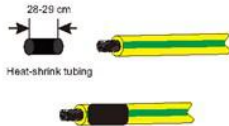

3) Insert the PE cable into the terminal.



4) Use a crimping tool to squish the terminal.

Installation



5) Use a hot-air blower to blow the heat-shrink tubing.

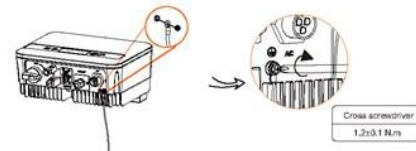
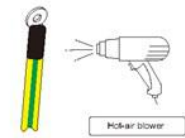

5.5.2 Communication interface

This product has a series of communication interfaces: such as WIFI, COM/CT.



APPENDIX B. X1 Series User Manual 0.6kW - 3.3kW. (Cont.)

Installation

and USB for upgrading for human and machine communication. Operating information like output voltage, current, frequency, faulty information, etc., can be delivered to PC or other monitoring equipment via these interfaces.

④ DONGLE Port

This inverter provides a DONGLE port which can collect information from inverter including status, performance and updating information to monitoring website via connecting Wi-Fi dongle (optional, purchase the product from supplier if needed)

Connection steps:

1. Plug the WiFi Dongle (optional) into "DONGLE" port at the bottom of inverter.
 2. Connect the WiFi with router.
 3. Scan below QR code or search for the keyword "Monitoring Cloud" in APP Store to download the corresponding APP for setting up the monitoring.
 4. Follow the steps to create a new account, set up internet connections and check the inverter status.
- (For more details of the monitoring configuration, please refer to the WiFi/LAN/GPRS/4G Dongle user manual in the box.)

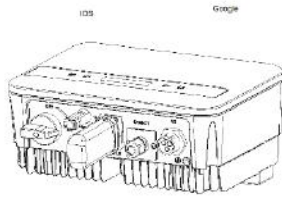

34

Installation

④ COM/CT Port

RS485 is one standard communication interface which can transmit the real-time data from inverter to PC or other monitoring equipment.

a. RS485 connection



The PIN definition of RS485 interface is shown as below.



PIN	1	2	3	4	5	6	7	8
Definition	X	X	X	485_A	485_B	X	X	X

➤ RS485 Connection Steps:

- 1) Firstly unscrew the screw from the COM/CT port. (PH1 cross screwdriver. Torque: 1.0±0.1N.m)
- 2) Prepare a communication cable and strip the insulation from it.
- 3) Let the communication cable pass through the waterproof connector, then insert it into the connector following the PIN definition rule.

Hand tighten.
Torque: 1.2±0.1N.m

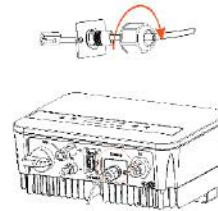

35



APPENDIX B. X1 Series User Manual 0.6kW - 3.3kW. (Cont.)

Installation

- b. Meter (optional) connection
 With this single phase meter working together with the inverter, you can:
 (1) Monitor the energy to grid and from grid through the whole day.
 (2) Achieve the export control function with a higher accuracy.

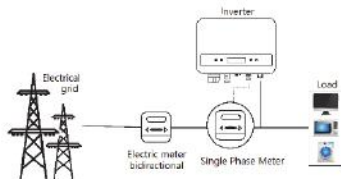

The PIN definition of Meter interface is shown as below.

4
5

PIN	1	2	3	4	5	6	7	8
Definition	X	X	X	485_A	485_B	X	X	X

➤ Meter Connection Steps:
 Please see the Quick Guide and User Manual for Single Phase Meter Installation for details.

Note!
 It is recommended to connect our Smart meter to inverter. If there is no smart meter installed, please disable the "Export Control" function in the inverter setting otherwise the inverter will stop and report a "Meter fault" alert. The "Export Control" is disabled by default, if an error occurs, please check if it is disabled.
 The smart meter must be purchased from and authorized by us, any third party or non-authorized meter may not match with the inverter. We will not take the responsibility if the meter is unavailable or incompatible in this case.

36

Installation

- CT Connection:
 The current sensor measures the current on the phase wire that runs between the inverter and the grid.

• CT connection diagram

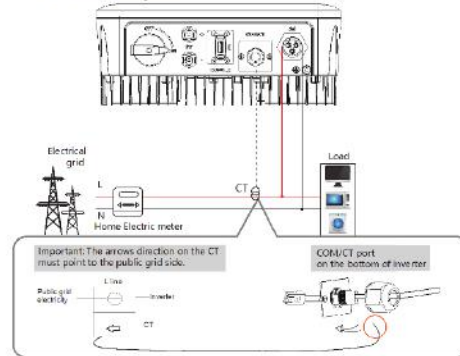

- CT PIN Definition
 When connecting the RJ45 connector with the wire of the CT, please follow the sequence below:

1
8

PIN	1	2	3	4	5	6	7	8
Definition	CT_+	X	X	X	X	X	X	CT_-

37



APPENDIX B. X1 Series User Manual 0.6kW - 3.3kW. (Cont.)

Installation

• CT Connection Steps:

NOTE!

- Do not place the CT on the N Wire or the earth wire.
- Do not place the CT on the N and L wire simultaneously.
- Do not place the CT with the arrow pointing to the inverter side.
- Do not place the CT on the non-insulated wires.
- Do not use the wire over 25m.

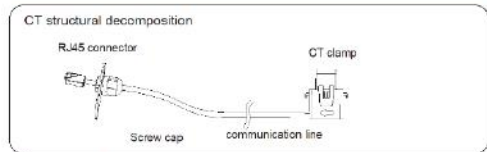

1. Insert the RJ45 connector of CT into the "RS485" port on the inverter, and screw down the screw cap tightly.
2. Make sure the current sensor is installed in the right direction: The arrow on the current sensor must point to the public grid.
3. Clip the CT clamp on L line from the home main meter box side.
4. Use electrical tape to prevent CT from falling off.

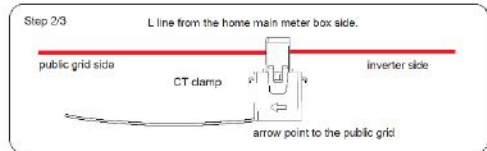

38

Installation

Ⓞ DRM

DRM function (for AS4777) is provided to support several demand response modes by giving control signals as below (For other countries, DRM function is used for remote shut-off). The user should follow the following PIN rules and cooperate with external equipment when using it.

— 2
— 7

PIN	1	2	3	4	5	6	7	8
Definition	X	DRM0	X	X	X	X	+3.3V_COM	X

DRM shares the terminal block with RS485/ Meter communications. For the connection steps of the DRM, user can refer to the above RS485 connections.

Note!
Only DRM0 is available now.

39



APPENDIX B. X1 Series User Manual 0.6kW - 3.3kW. (Cont.)

Installation

Heat Pump Connection

Adapter box is provided to control the closing and breaking of switches by giving control signals. It can also be used to control heat pump via Adapter Box.

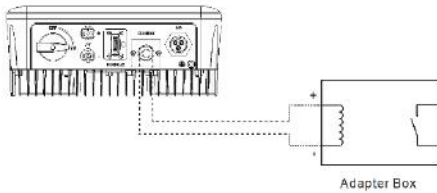

The PIN definition of heat pump is as below:

— 3
— 6

PIN	1	2	3	4	5	6	7	8
Definition	X	X	GND_COM	X	X	RY_OUT	X	X

Heat Pump Connection Steps:

- 1) Connect RY_OUT to the positive pole of the heat pump load and connect GND_COM to the negative pole of the heat pump load.
- 2) The heat pump function is disabled by default. Please enable it in the setting.



38

Installation

→ To enable the heat pump function:

2.1) Enter the Settings interface and choose DryContact.



2.2) There are 3 modes for selection after you enter the DryContact interface: Load Management, SmartSave and Generator. Choose SmartSave and then select Enable in the Schedule interface.

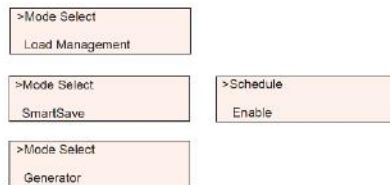

3) Set the time intervals for opening and closing the heat pump.

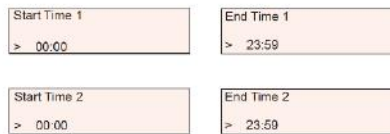

39



APPENDIX B. X1 Series User Manual 0.6kW - 3.3kW. (Cont.)

Installation

5.6 EV-Charger Function

The inverter can communicate with the smart EV-Charger to form an intelligent photovoltaic, storage and EV charging energy system, thus maximizing the utilization of photovoltaic energy.

Diagram: Intelligent Photovoltaic, Storage and EV Charging Energy System

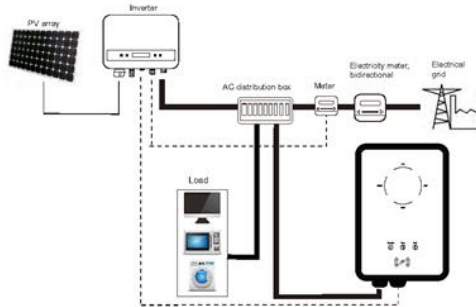

Wiring operation

- a) Plug one terminal of the communication cable to the right pin of the EV-Charger and the other terminal to PIN 4 & 5 of the "COM/CT" port of the inverter.
- b) Connect the meter to PIN 4 & 5 of the "COM/CT" port of the inverter.

Setting

Turn on the power of the entire system, enter the "Settings" page of the inverters on the LCD screen.

- a) Enter the "Export Control" page and chose "CT" or "Meter".

> Export Control
DRM Function

> Mode Select
Meter

> Mode Select
CT

40

Installation

- b) Select "EvChargerEnable" and then enter "Mode Select". Ensure the interface shows "Enable" under "Mode Select", which indicates the EV-Charger function started successfully.

>EvChargerEnable
Adapter Box

>Mode Select
Enable

For the installation and settings of the EV-Charger, please refer to the user manual of the EV-Charger for details.

Note!
The EV-Charger function and the parallel system with Datahub or the parallel system with Modbus Function cannot be used at the same time currently.

④ Upgrade

User can update the inverter system through the USB flash driver.

WARNING!
Make sure the input voltage is more than 100 V dc (in good illumination condition), otherwise it may result in failing during updating.

> Upgrade Steps:

- 1) Please contact our service support to get the update file, and extract it into your USB flash driver as the following file path:

"Update\ARM\323101023800_X1_MINI_G4_ARM_VXXX.XX_XXXXXXXXX.bin";
"Update\DSP\323101023700_X1_MINI_G4_DSP_VXXX.XX_XXXXXXXXX.bin".

Note: Vx.xx is version number, xxxxxxxx is file completion date.

WARNING!
Make sure the directory is in accordance with above form strictly!
Do not modify the program file name! Otherwise it may cause the inverter not to work anymore!

41



APPENDIX B. X1 Series User Manual 0.6kW - 3.3kW. (Cont.)

Installation

Installation

NOTE!
The format of U-disk system shall be FAT32.

2) Insert USB flash drive with update program into the DONGLE port on the bottom of the inverter. Turn on DC switch or connect the PV connector.

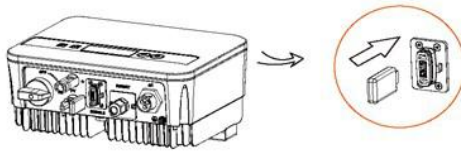

3) Short press up and down key to select the one that you want to update and long press down key to confirm.

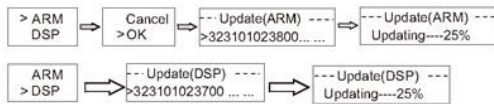

4) After the upgrade is completed, please pull off the U-disk.

WARNING!
If the upgrade fails, please repeat the above operation.

5.6 Run the Inverter

> Start inverter after checking all below steps:

- a) Check that device is fixed well on the wall.
- b) Make sure the DC breaker and AC breaker are disconnected.
- c) AC cable is connected to grid correctly.
- d) The DC cable is properly and reliably connected;
- e) The ground cable is properly and reliably connected;
- f) The communication cable is properly and reliably connected.
- g) All PV panels are connected to inverter correctly.
- h) No foreign items, such as tools, are left on the top of the machine or in the junction box (if there is).
- I) Turn on the external DC and then AC connectors.
- j) Turn on the DC switch to the "ON" position.

> Start the inverter

- a) Inverter will start automatically when PV panels generate enough energy.
- b) Check the status of LED indication and LCD screen, the LED indication should be blue and the LCD screen should display the main interface.
- c) If the LED indication is not blue, please check the following conditions:
 - All the connections are correct.
 - All the external disconnect switches are closed.
 - The DC switch of the inverter is in the "ON" position.

> The following is the three status when operating, which means inverter starting up successfully.

Status	Description
Waiting	Inverter is waiting to check when DC input voltage from panels is greater than 40 V (start-up voltage) but less than 50 V (lowest operating voltage). When the inverter with auxiliary power supply lacks PV, the screen also shows "waiting".
Checking	Inverter will check DC input environment automatically when DC input voltage from the PV panels exceeds 50 V and PV panels have enough energy to start inverter.
Normal	Inverter begins to operate normally when the blue light is constantly on. Meanwhile feedback energy to grid (if condition permits). LCD displays present output power.



Compliance Evaluation Report



REPORT No.: CSSC/BOS/005

ISSUED DATE: March 9, 2023

APPENDIX B. X1 Series User Manual 0.6kW - 3.3kW. (Cont.)

Installation

Enter the setting interface to follow the instructions when it is first time to start up.



WARNING!

Power to the unit must be turned on only after installation work has been completed. All electrical connections must be carried out by qualified personnel in accordance with legislation in force in the country concerned.



NOTE!

Please set the inverter according to local requirements.

Isolation Fault Alarm

The isolation fault alarm installed into the inverter, is the standard configuration, as required by AS 4777_2020 and New Zealand, it will give a visual alarm once the isolation impedance of the PV arrays is less than 20 KΩ. The error indicator light will be in red and the control panel will display isofault.

44

Installation

Commissioning

Please select Australia Region A, B, C for power quality response modes and grid protection settings during commissioning.

- You can adjust setpoints for power quality response modes and grid protection settings if required.

After commissioning, you can view the following settings through the LCD of the inverter after commissioning:

- Firmware version
- Region settings (and setpoints) for grid protection settings
- Region settings (and setpoints) for power quality response modes.



NOTE!

Once settings are selected at commissioning they are locked to view only.



NOTE!

Password should not be readily available – if you need that, you can find the password that either in a separate maintenance/service manual or available from manufacturer/importer upon request

45



APPENDIX B. X1 Series User Manual 0.6kW - 3.3kW. (Cont.)

Operation Method

6. Operation Method

6.1 Control panel

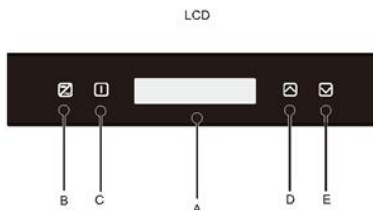

Object	Name	Description
A	LCD Screen	Display the information of the inverter.
B	Indicator LED	Light in blue: The inverter is in normal status. Flash in blue: The inverter is in waiting status.
C		Light in red: The inverter is in fault status.
D	Function Button	Up/ESC button: Short press to move cursor up or increase value. Long press to return from the current interface function.
E		Down/Enter button: Short press to move cursor down or decrease value. Long press to confirm and change parameters.

Note: When the inverter is in "Waiting" and "Checking" status, the blue light "B" is flashing; when in "Normal" status, the blue light "B" is always on.

Operation Method

6.2 LCD Structure

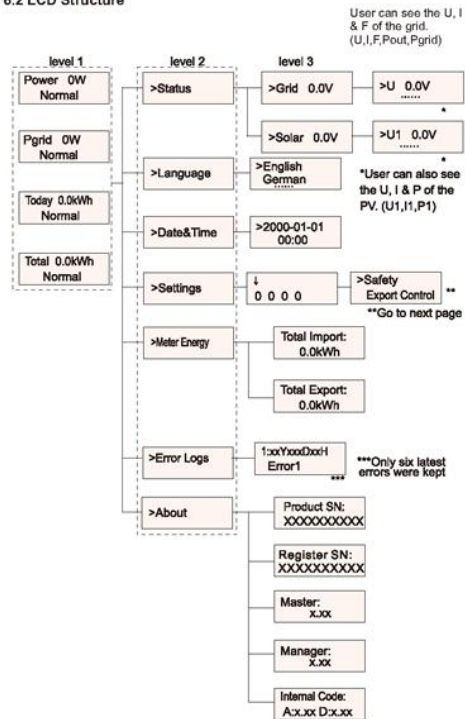



Compliance Evaluation Report



REPORT No.: CSSC/BOS/005

ISSUED DATE: March 9, 2023

APPENDIX B. X1 Series User Manual 0.6kW - 3.3kW. (Cont.)

Operation Method

6.3 LCD Operation

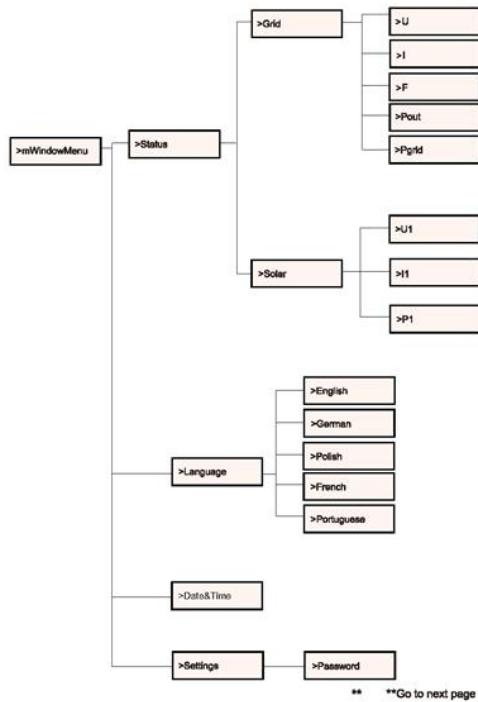

50

Operation Method

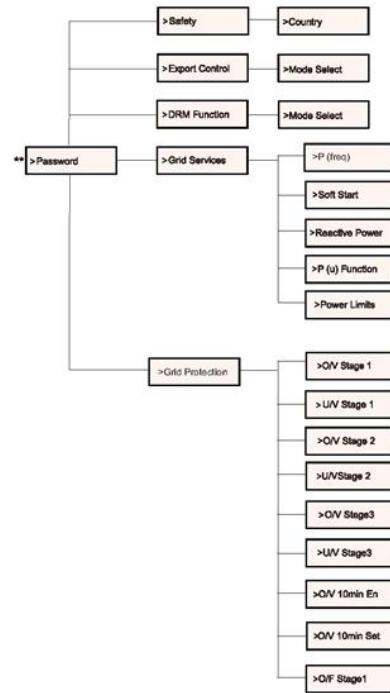

51



Compliance Evaluation Report



REPORT No.: CSSC/BOS/005

ISSUED DATE: March 9, 2023

APPENDIX B. X1 Series User Manual 0.6kW - 3.3kW. (Cont.)

Operation Method

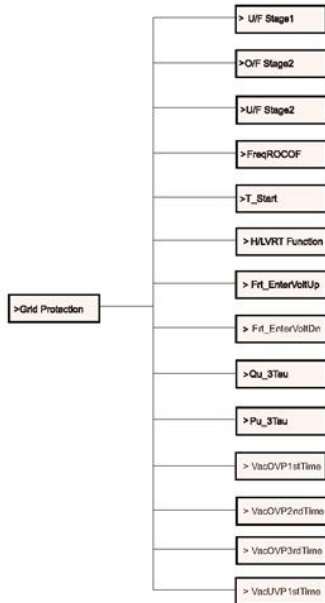

52

Operation Method

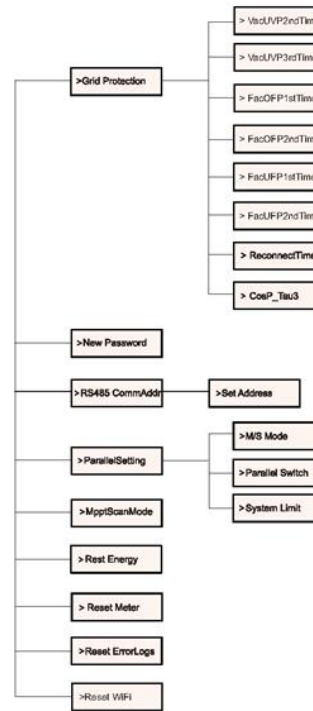

**Go to next page

53



APPENDIX B. X1 Series User Manual 0.6kW - 3.3kW. (Cont.)

Operation Method

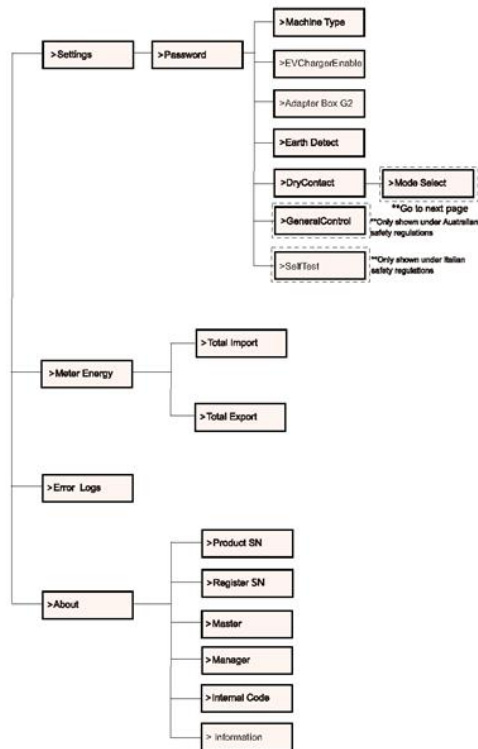

52

Operation Method

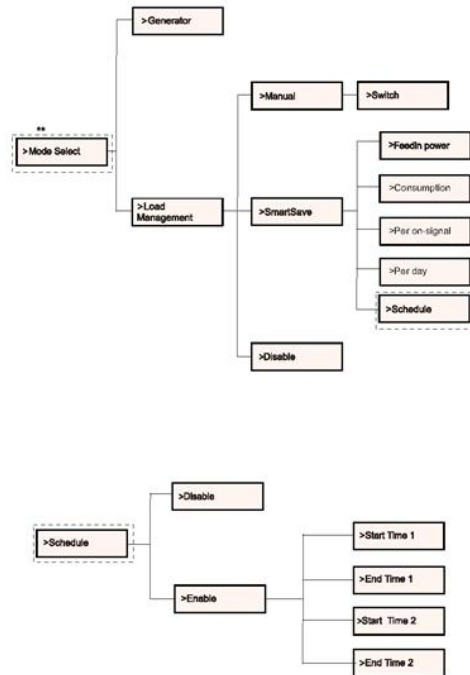

53



Compliance Evaluation Report



REPORT No.: CSSC/BOS/005

ISSUED DATE: March 9, 2023

APPENDIX B. X1 Series User Manual 0.6kW - 3.3kW. (Cont.)

Operation Method

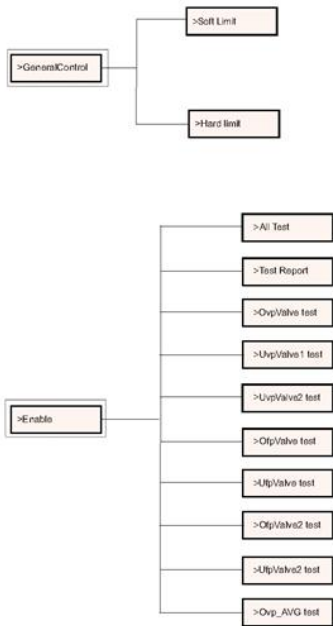

52

Operation Method

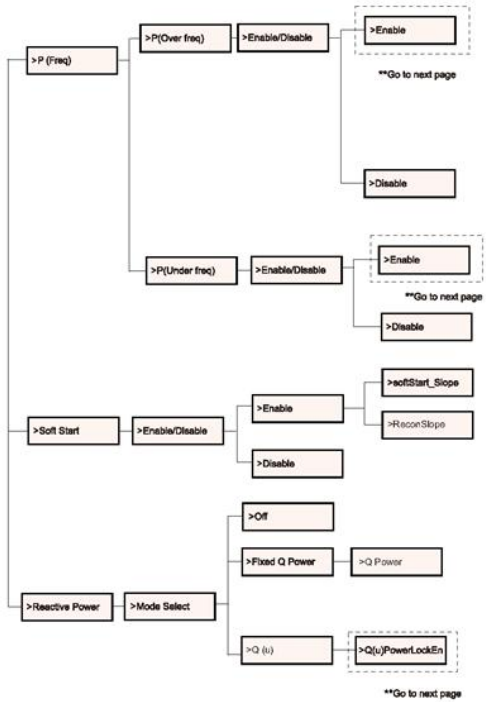

53



APPENDIX B. X1 Series User Manual 0.6kW - 3.3kW. (Cont.)

Operation Method

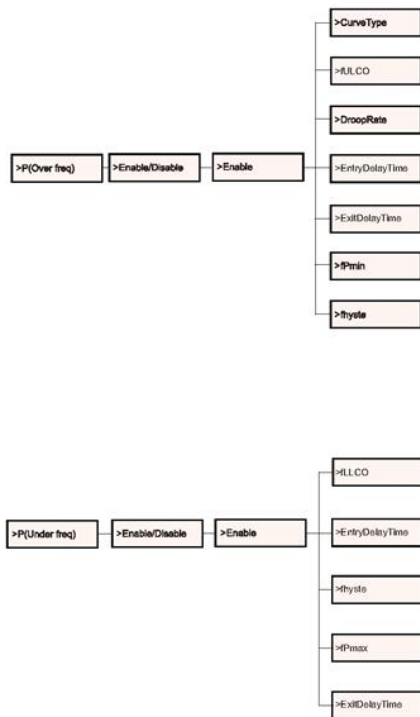

52

Operation Method

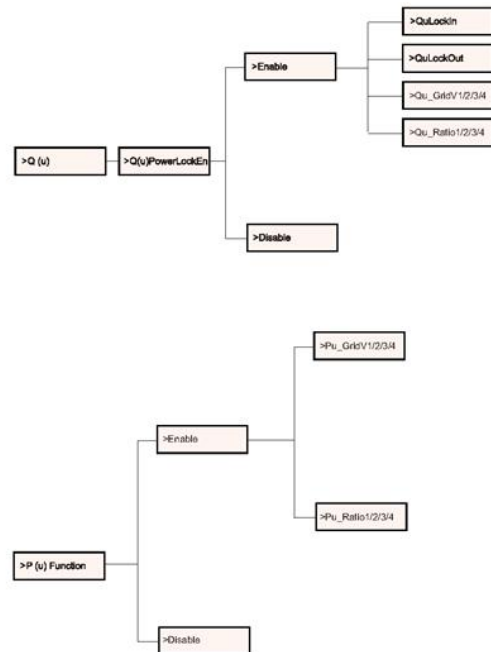

53



Compliance Evaluation Report



REPORT No.: CSSC/BOS/005

ISSUED DATE: March 9, 2023

APPENDIX B. X1 Series User Manual 0.6kW - 3.3kW. (Cont.)

Operation Method

> LCD Display

• Level 1

Power 0W Normal	Pgrid 0W Normal	Today 0.0kWh Normal	Total 0.0kWh Normal
--------------------	--------------------	------------------------	------------------------

1) The first line displays the parameters(Power, Pgrid, Today and Total) and the values.

Parameter	Meaning
Power	The output power of inverter.
Pgrid	The power export to or import from the grid; (Positive value means the energy feeds into grid, negative value means the energy used from the grid).
Today	The power generated within the day.
Total	The power generated in total.

2) The second line shows the running status.

"Normal" means the running status of the inverter.

• Level 2

Long press the "Enter" button to enter the second-level interface.

User can see parameters, such as the Status, Language, Date Time, Settings (need password), Meter energy (including Total Import, Total Export), Error Logs (of the inverter), and About (the user can browse the information of the inverter, including product serial number, machine type, register sn, master, slave, manager and internal code).

..... Menu

>Status Language

a) Status

The status function contains two aspects: the grid and the solar.

Press "Up" and "Down" to select and long press "down" to confirm the selection, long press "Up" to return to Menu.

54

Operation Method

..... Status

>Grid Solar

1) Grid

This status shows the current condition of the AC output port of the inverter, such as voltage, current, output power and grid power.

This status includes 5 parameters: U, I, F, Pout, Pgrid.

Press "Up" and "Down" to select and long press "down" to confirm the selection, long press "Up" to return.

..... Grid

>U	0.0V
I	0.0A

2) Solar

This status shows the real time PV condition of the system, such as input voltage, current and power situation of each PV input.

This status includes 6 parameters: U1, I1, P1.

Press "Up" and "Down" to select and long press "down" to confirm the selection, long press "Up" to return

..... Solar

>U1	0.0V
I1	0.0A

b) Language

Users can select a language from English, German, Polish, French, Portuguese, Chinese, Spanish, Italian and Dutch by this function.

..... Language

>English German

c) Date Time

This interface is for the user to set the system date and time. Increase or decrease the word by pressing "Up" or "Down" button. Long press "Down"

55



Compliance Evaluation Report



REPORT No.: CSSC/BOS/005

ISSUED DATE: March 9, 2023

APPENDIX B. X1 Series User Manual 0.6kW - 3.3kW. (Cont.)

Operation Method

to confirm and alternate to next parameter. After all the numbers are confirmed. Long press "Down" to enter the date and time.

..... Date&Time

>2000-01-01
00: 00

d) Settings

This function is used for setting the inverter.

..... Settings

↓
1 0 0 0

* Password

The default password is "2014" for the installer, which only allows the installer to review and modify necessary settings complying to the local rules and regulations. If further advanced setting is required, please contact the distributor or us for assistance. We need to increase or decrease the word by pressing up or down button. Long press "Down" to confirm and alternate to the next number.

..... Settings

↓
1 0 0 0

After inputting the password, the information of the LCD interface is shown as below.

..... Settings

>Safety
Export Control

1) Safety

The user can set the safety standard here according to different countries and grid tied standards. There are several standards for choice (May change without notice). In addition, the user has an "UserDefined" option which allows the user to customize relevant parameters within a wider range.

56

Operation Method

..... Safety

>Country
VDE4105

NOTE!
The grid standard needs to be set as different regions according to local requirements. If there is any doubt, please consult our service technicians for details.

The default settings for different regions are shown as follows:

Region	Australia A	Australia B	Australia C	New Zealand	Setting Range
Standard Code	AS4777_2020_A	AS4777_2020_B	AS4777_2020_C	New Zealand	
OV-G-V	265V	265V	265V	265V	230-300V
OV-G-V1	1.55	1.55	1.55	1.55	
OV-G-V2	275V	275V	275V	275V	230-300V
OV-G-V2-T	0.15	0.15	0.15	0.15	
UN-G-V1	180V	180V	180V	180V	40-230V
UN-G-V1-T	1.05	1.05	1.05	1.05	
UN-G-V2	70V	70V	70V	70V	40-230V
UN-G-V2-T	1.55	1.55	1.55	1.55	
OV-G-F1	50Hz	50Hz	50Hz	50Hz	50-59Hz
OV-G-F1-T	0.15	0.15	0.15	0.15	
OV-G-F2	52Hz	52Hz	50Hz	50Hz	50-59Hz
OV-G-F2-T	0.15	0.15	0.15	0.15	
UN-G-F1	47Hz	47Hz	48Hz	48Hz	45-60Hz
UN-G-F1-T	1.55	1.55	55	55	
UN-G-F2	47Hz	47Hz	48Hz	48Hz	45-59Hz
UN-G-F2-T	1.55	1.55	55	55	
Startup-T	60S	60S	60S	60S	15-1000S
Restart-T	60S	60S	60S	60S	15-600S
Recover-VH	253V	253V	253V	253V	
Recover-VL	255V	255V	255V	198V	
Recover-FH	50.15Hz	50.15Hz	50.15Hz	50.15Hz	
Recover-FL	47.5Hz	47.5Hz	47.5Hz	47.5Hz	
Start-VH	253V	253V	253V	253V	
Start-VL	255V	255V	255V	198V	
Start-FH	50.15Hz	50.15Hz	50.15Hz	50.15Hz	
Start-FL	47.5Hz	47.5Hz	47.5Hz	47.5Hz	

2) Export Control

With this function the inverter can control energy exported to the grid. Whether having this function is based on user's wishes. Choose "Disable" means the function will be shut off. The user value set by installer must be within the range of 0 kW to 60 kW. Press "Up" and "Down" button to select and long press "Down" to confirm.

57



APPENDIX B. X1 Series User Manual 0.6kW - 3.3kW. (Cont.)

Operation Method

Operation Method

..... Export Control

>Mode Select
Disable/Meter/CT

4-2. Reactive power control, Reactive standard curve $\cos \phi = f(P)$
 For VDE ARN 4105, curve $\cos \phi = f(P)$ should refer to curve A. Default values of setting are as shown in curve A.
 For E 8001, curve $\cos \phi = f(P)$ should refer to curve B. Default values of setting are as shown in curve B.

Reactive power control, Reactive standard curve $Q = f(V)$

$V2 = 1.10V_n$
 $V1 = 1.08V_n = Q_{ul}/\text{ViewRate}$
 $V2 = 0.90V_n$
 $V2 = 0.92V_n = Q_{ll}/\text{ViewRate}$

60

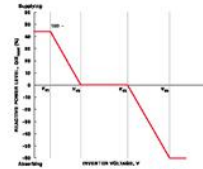

Figure 4-2-1 Setting reactive power control curve

Voltage 1(Vv1): 190-230V
 (Default: AS4777_2020_A(207V);AS4777_2020_B(205V);AS4777_2020_C(215V);New Zealand(207V))
 Voltage 2(Vv2): 190-230V
 (Default: AS4777_2020_A(220V);AS4777_2020_B(220V);AS4777_2020_C(230V);New Zealand(220V))
 Q-Limit 2(Qv2): 0%
 Voltage 3(Vv3): 230V-285V
 (Default: AS4777_2020_A(240V);AS4777_2020_B(235V);AS4777_2020_C(240V);New Zealand(235V))
 Q-Limit 3(Qv3): 0%
 Voltage 4(Vv4): 230V-285V
 (Default: AS4777_2020_A(255V);AS4777_2020_B(255V);AS4777_2020_C(255V);New Zealand(244V))
 Vv1 Leading(Supplying): +30~+60%
 (Default: AS4777_2020_A(+44%);AS4777_2020_B(+30%);AS4777_2020_C(+44%);New Zealand(+60%))
 Lagging(Absorbing): -30~-60%
 (Default: AS4777_2020_A(-60%);AS4777_2020_B(-40%);AS4777_2020_C(-60%);New Zealand(-60%))

5. P(u) Function

This function can limit the power, There are several values to be set.

3) DRM Function

Installer can choose "Enable" to control the inverter's power off through the external communication.

..... DRM Function

>DRM Function
Enable/Disable

61



Compliance Evaluation Report



REPORT No.: CSSC/BOS/005

ISSUED DATE: March 9, 2023

APPENDIX B. X1 Series User Manual 0.6kW - 3.3kW. (Cont.)

Operation Method

4) Grid Services
 Usually end user do not need to set the grid parameters. All default value have been set before leaving factory according to safety rules.
 If reset is needed, any changes should be made according to the requirements of local grid.

..... Grid Service

>P (freq)
Soft Start

1. P(freq)

> P(Overfreq)	If reset is needed, any changes should be made according to the requirements of local grid.
P(Underfreq)	

2. Soft Start

> Enable/Disable	If reset is needed, any changes should be made according to the requirements of local grid.
>Disable <	

3.

Soft Start_Slope	If set as shown, 9 percent of the rated power increase per minute.
9%	

58

Operation Method

4-1.

..... Reactive Power

> Mode Select	If reset is needed, any changes should be made according to the requirements of local grid.
>Off <	

Mode Select	Comment
Off	-
Over-Excited	PF value
Under-Excited	PF value
PF(P)	PowerFactor 1/2/3/4
	PowerRatio 1/2/3/4
	EntryVolt
Q(u)	ExitVolt
	Q(u) PowerLockEn
	Q(u) LockIn
	Q(u) LockOut
Fix Q Power	Q(u) GridV1/2/3/4
	QuRatio1/2/3/4
	Q Power

NOTE!
 The terms shown in the interface depend on the local safety regulations.

59



APPENDIX B. X1 Series User Manual 0.6kW - 3.3kW. (Cont.)

Operation Method

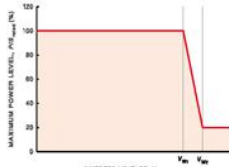

Figure – Example curve for the sub-opt response mode

Status Enable/Disable (Note: This is used to enable or disable the Volt-Watt mode)
 Voltage 1 (Vw1): 235V-255V
 (Default: AS4777_2020_A(253V); AS4777_2020_B (250V); AS4777_2020_C(253V); New Zealand(242V))
 P-Limit 1(Vw1): 100%
 Voltage 2(Vw2): 240V-255V
 (Default: AS4777_2020_A (250V); AS4777_2020_B (250V); AS4777_2020_C(250V); New Zealand(250V))
 P-Limit 2(Vw2): 0-20%(Default: 20% for AS4777_2020_A; AS4777_2020_B ; AS4777_2020_C; New Zealand)

6. Power Limits

> Proportion
0.00

User can set the power limit here, the setting value is between 0.00 and 1.1.

5) Grid Protection
 Usually end user do not need to set the grid Protection. All default values have been set before leaving factory according to safety rules. If reset is needed, any changes should be made according to the requirements of local grid.

..... Export Control

> O/V Stage1
0.0

6) New Password
 The user can set the new password here. We need to increase or decrease the word by pressing "Up" or "Down" button. Long press "Down" to confirm and alternate to next word. After word is confirmed, long press "Down" to reset the password.

Operation Method

..... New Password.....

>
0 0 0 0

7) RS485 CommAddr
 If "Enable" is selected, the inverter will communicate with the computer, through which the operating status of the inverter can be monitored. When multiple inverters are monitored by one computer, RS485 communication addresses of different inverters need to be set. RS485 function will only be effective when the address is identical. The default address is "1".

..... RS485 CommAddr.....

> Set Address
2

8) ParallelSetting
 When the user wants to use the parallel system with Modbus Function, enable this function and complete the settings following the instructions in section "Parallel Connection". If not needed, disable this function.

..... ParallelSetting

> Parallel Switch
Enable

9) Mppt Scan Mode
 There are 4 modes for selection: "Off", "LowFreqScan", "MidFreqScan", "HighFreqScan". It shows the frequency of PV panel scan. If "LowFreqScan" is selected, the inverter will scan the PV panel by low frequency. Time for LowFreqScan: 4h; for MidFreqScan: 3h; for HighFreqScan: 1h..

..... Mppt Scan Mode.....

Mode Select
>Off<



APPENDIX B. X1 Series User Manual 0.6kW - 3.3kW. (Cont.)

Operation Method

10) Reset Energy

The user can clear the power energy of CT and meter by this function (if the user uses meters)



11) Reset Meter

The user can clear the meter and CT energy by this function. Press "Up" or "Down" button to select and long press "Down" to confirm. (The user can select "Yes" to reset meter if the user uses meters)

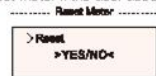

12) Reset Errorlog

The user can clear the errorlogs by this function. Press "Up" or "Down" button to select and long press "Down" to confirm.

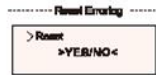

13) Reset WIFI

The user can restart the WIFI by this function.

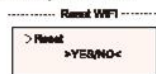

14) Machine Type

The user can check the Machine Type by this function.

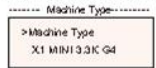

15) EvChargerEnable

The user can turn on EvCharger function by select "Enable".

Operation Method

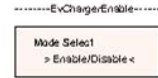

15) Adapter Box G2

The user can connect the adapter box by this function

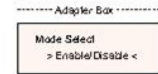

17) Earth Detect

The user can enable or disable the Earth Detect by this function.

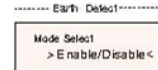

18) Dry Contact

The user can use the Dry Contact to connect heat pump by this function (require SG Ready).



There are three functions(Disable/Manual/Smart Save) which can be selected for Load Management. "Disable" means the heat pump is off. When "Manual" is selected the user can control the external relay to remain close or open manually. "Smart Save" mode can set the values of the heat pump's on/off time and conditions, operating modes. If the user uses the inverter dry contacts to control heat pump through Adapter box, please refer to the Adapter Box Quick Installation Guide to set the parameters here.



APPENDIX B. X1 Series User Manual 0.6kW - 3.3kW. (Cont.)

Operation Method

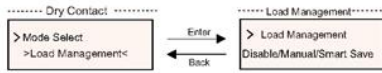

19) General Control
Under the Australia safety regulations, general control will show as meter control.



• Meter Energy
The user can check the import and export energy by this function. There are four parameters: "Total Import", "Total Export". Press "Up" and "Down" to browse the values.

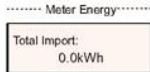

• Error Logs
The Error log contains error information happened. It can record six items at most. Press "Up" and "Down" button to review parameter. Long press "up" to return to the main interface.



• About
This interface shows information of the inverter, including "Product SN", "Register SN", "Master", "Manager" and "Internal Code".



Operation Method

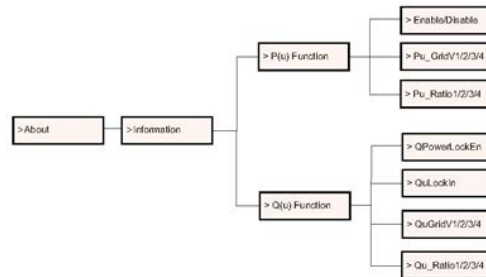

• Level 3
Long press the "Enter" button to enter the third-level interface.

- a) Status: The user can see the U/I/P parameters of the grid and the PV, such as the Ugrid, Igrid, P and F of the grid, and the Usolar, Isolar and Psolar of the PV.
- b) Language: This inverter provides several languages for customer to choose.
- c) Settings: Entering the installer password, the information of the LCD interface is shown in the previous page.
 - (1) Safety: The user can set the right safety standard here.
 - (2) Grid: Usually end user do not need to set the grid parameters.

If you need to reset, any changes should comply with the requirement of local grid.



Compliance Evaluation Report



REPORT No.: CSSC/BOS/005

ISSUED DATE: March 9, 2023

APPENDIX B. X1 Series User Manual 0.6kW - 3.3kW. (Cont.)

Operation Method

Parameter	Comment
Para	
O/V Stage1	Slow overvoltage point
U/V Stage1	Slow undervoltage point
O/V Stage2	Rapid overvoltage point
U/V Stage2	Rapid undervoltage point
O/V Stage3	Stage-3 rapid overvoltage point
U/V Stage3	Stage-3 rapid undervoltage point
O/V 10min En	10 min average overvoltage enabled
O/V 10min Set	10 min average overvoltage setting value
O/F Stage1	Slow overfrequency point
U/F Stage1	Slow underfrequency point
O/F Stage2	Rapid overfrequency point
U/F Stage1	Rapid underfrequency point
FreqROCOF	Rate of frequency change
T_Start	Self-test time
H/LVRT Function	High/low voltage ride enabled
Frt_EnterVoltDn	Entry value of low voltage ride through
Qu_3Tau	Reactive step response time constant
Pu_3Tau	Active step response time constant
VacOVP1stTime	Stage-1 overvoltage protection time
VacOVP2ndTime	Stage-2 overvoltage protection time
VacOVP3rdTime	Stage-3 overvoltage protection time
VacUVP1stTime	Stage-1 undervoltage protection time
VacUVP2ndTime	Stage-2 undervoltage protection time
VacUVP3rdTime	Stage-3 undervoltage protection time
FacOFP1stTime	Stage-1 overfrequency protection time
FacOFP2ndTime	Stage-2 overfrequency protection time
FacUFP1stTime	Stage-1 underfrequency protection time
FacUFP2ndTime	Stage-2 underfrequency protection time
ReConnectTime	Reconnect time
CosP_Tau3	Power factor step response time constant
Frt_EnterVoltUp	Entry value of high voltage ride through

68

Operation Method

(3) Power Factor: (For specific country if required by the local grid.)
There are 6 modes for selecting: Off, Under-Excited, Over-Excited, PF (p), Q (u).

All parameters are shown below.

Mode	Comment
Off	
Under excited	PF Value
Over excited	PF Value
PF(p)	PowerFactor1
	PowerFactor2
	PowerFactor3
	PowerFactor4
	PowerRatio1
	PowerRatio2
	PowerRatio3
	PowerRatio4
Q(u)	EntryVolt
	ExitVolt
	QPowerLockEn
Fixed Q Power	Q LockIn
	Q LockOut
	QuGridV1/2/3/4
	QuRatio1/2/3/4
	Q Power

For VDE 4105, curve $\cos \phi = f(P)$ should refer to curve A. The default setting values are as shown in curve A.

For TOR, curve $\cos \phi = f(P)$ should refer to curve B. default values of setting are as shown in curve B.

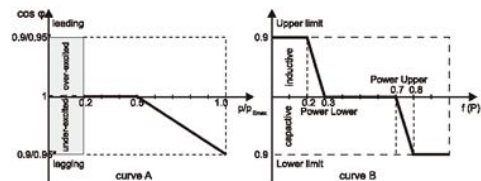

69



APPENDIX B. X1 Series User Manual 0.6kW - 3.3kW. (Cont.)

Operation Method

Operation Method

7 Troubleshooting

7.1 Troubleshooting

This section contains information and procedures for solving possible problems with the inverters, and provides you with troubleshooting tips to identify and solve most problems that could occur with the inverters.

This section will help you narrow down the source of any problems you may encounter. Please read the following troubleshooting steps.

Check warnings or fault messages on System Control Panel or Fault codes on the inverter information panel. If a message is displayed, record it before doing anything further.

Attempt the solution indicated in troubleshooting lists.

If your inverter's information panel is not displaying a Fault light, check the following list to make sure that the present state of the installation allows proper operation of the unit.

- Is the inverter located in a clean, dry, adequately ventilated place?
- Have the DC input breakers been opened?
- Are the cables adequately sized and short enough?
- Are the input and output connections and wiring in good condition?
- Are the configurations settings correct for your particular installation?
- Are the display panel and the communications cable properly connected and undamaged?

Contact our Customer Service for further assistance. Please be prepared to describe details of your system installation and provide model and serial number of the unit.

70

71



Compliance Evaluation Report



REPORT No.: CSSC/BOS/005

ISSUED DATE: March 9, 2023

APPENDIX B. X1 Series User Manual 0.6kW - 3.3kW. (Cont.)

Troubleshooting

Code	Faults	Diagnosis and solution
IE:00001	TzFault	Over Current Fault. -Wait for about 10 seconds to check if the inverter is back to normal. -Disconnect the DC switch and restart the inverter. -Or consult us for solutions.
IE:00002	GridLossFault	Grid Lost Fault. -Check if the main cable is loose. -Wait for a while and the system will reconnect when the utility is back to normal. -Or consult us for solutions.
IE:00003 IE:00004 IE:00005	GridVoltFault	Grid Voltage Out of Range. -Check if the main cable is loose. -Wait for a while and the system will reconnect when the utility is back to normal. -Or consult us for solutions.
IE:00006 IE:00007 IE:00008	GridFreqFault	Grid Frequency Out of Range. -Wait for a while and the system will reconnect when the utility is back to normal. -Or consult us for solutions.
IE:00009	PVVoltFault	PV Voltage Fault. -Check whether the PV is overvoltage. -Or consult us for solutions.
IE:00010 IE:00011 IE:00012	BusVoltFault	DC Bus Voltage Out of Normal Range. -Check if the PV input voltage is within the operating range of the inverter. -Disconnect PV wiring and reconnect. -Or consult us for solutions.
IE:00012	GridVolt10MFAult	Grid Overvoltage for Ten Minutes Fault. -The system will reconnect when the utility is back to normal. -Or consult us for solutions.
IE:00013	DcInjOCP	DC Overcurrent Protection Fault. -Wait for a while to check if the inverter is back to normal. -Or consult us for solutions.
IE:00034	HardLimitFault	Hard Limit Fault (in Australian standard). -Wait for a while to check if the inverter is back to normal. -Or consult us for solutions.
IE:00018 IE:00019	ResidualOCP	Overcurrent Protection Fault. -Check the connections of the inverter. -Wait for a while to check if the inverter is back to normal. -Or consult us for solutions.
IE:00020	IsrFault	Isolation Fault. -Check the connections of the inverter. -Or consult us for solutions.
IE:00021	OverTempFault	Over Temperature Fault. -Check if the inverter and the ambient temperature exceeds the operating range. -Or consult us for solutions.
IE:00055	EarthFault	Earth Fault. -Check if the earth is connected properly -Or consult us for solutions.

76

Troubleshooting

Code	Faults	Diagnosis and solution
IE:00029	LowTempFault	Low Temperature Fault. -Check if the ambient temperature is too low. -Or consult us for solutions.
IE:00038	InternalComFault	Internal Communication Fault. -Restart the inverter to check if it is back to normal. -Update the ARM software or return the program. -Or consult us for solutions.
IE:00037	EepromFault	DSP EEPROM Fault. -Disconnect PV wiring and reconnect. -Or consult us for solutions.
IE:00038	RcDeviceFault	Residual Current Device Fault. -Restart the inverter. -Update the ARM software or return the program. -Or consult us for solutions.
IE:00041 IE:00042 IE:00043 IE:00044	PVConnDirFault	PV Direction Fault. -Check if the PV+/- slides are connected correctly. -Or consult us for solutions.
IE:00039 IE:00056	GridRelayFault	Relay Fault. -Check the grid connection. -Restart the inverter. -Or consult us for solutions.
ME:00103	Mgr EEPROM Fault	ARM EEPROM Fault. -Disconnect PV and grid, then reconnect. -Or consult us for solutions.
ME:00105	Meter Fault	Meter Fault. -Check the connection of the meter. -Check if the meter is in working order. -Or consult us for solutions.
ME:00101	PowerTypeFault	Power Type Fault. -Check the version of ARM and DSP. -Check the product SN number. -Or consult us for solutions.
ME00104	Mgr Comm Fault	Mgr InterCom Fault. -Shut down photovoltaic, battery and grid, reconnect. -Or ask for help from the installer if it can not return to normal.
IE:00016	SW OCP Fault	Software Overcurrent Protection Fault. -Wait for a while to check if the inverter is back to normal. -Disconnect PV and grid, then reconnect. -Or consult us for solutions.

77



APPENDIX B. X1 Series User Manual 0.6kW - 3.3kW. (Cont.)

Troubleshooting

7.2 Routine Maintenance

Inverters do not need any maintenance or correction in most condition, but if the inverter often loses power due to overheating, this can be the following reason:

The cooling fins on the rear of house are covered by dirt.
Clean the cooling fins with a soft dry cloth or brush if necessary.
Only trained and authorized professional personnel who are familiar with the requirements of safety were allowed to perform servicing and maintenance work.

Safety checks

Safety checks should be performed at least every 12 months by manufacturer's qualified person who has adequate training, knowledge, and practical experience to perform these tests. The data should be recorded in an equipment log. If the device is not functioning properly or fails any of test, the device has to be repaired. For safety check details, refer to this manual, section 2 Safety instruction and EC Directives.

Maintain periodically

Only qualified person may perform the following works.
During the process of using the inverter, the manage person shall examine and maintain the machine regularly. The concrete operations are as follows.

- 1) Check that if the cooling fins on the rear of house are covered by dirts, and the machine should be cleaned and absorbed dust when necessary. This work shall be check time to time.
- 2) Check that if the indicators of the inverter are in normal state, check if the keys of the inverter are in normal state, check if the display of the inverter is normal. This check should be performed at least every 6 months.
- 3) Check that if the input and output wires are damaged or aged. This check should be performed at least every 6 months.
- 4) You should get the inverter panels cleaned and their security checked at least every 6 months.

78

Decommissioning

8 Decommissioning

8.1 Dismantling the Inverter

- Disconnect the inverter from DC Input and AC output.
- Wait for 5 minutes for de-energizing.
- Remove the inverter from the bracket.
- Remove the bracket if necessary.



WARNING!

Before dismantling the inverter, please be sure to disconnect the DC switch, and then unplug the PV and AC cables, otherwise it will lead to an electric shock hazard.
Do not touch any inner live parts until for at least 10 minutes after disconnecting the inverter from the utility grid and the PV input.

8.2 Packaging

If possible, please pack the inverter with the original packaging.
If it is no longer available, you can also use an equivalent carton that meets the following requirements.

- Suitable for loads more than 30 kg.
- With handle.
- Can be fully closed.

8.3 Storage and Transportation

Store the inverter in dry place where ambient temperatures are always between -25 °C - +60 °C. Take care of the inverter during the storage and transportation, keep less than 4 cartons in one stack.

When the inverter or other related components need to be disposed. Have it carried out according to local waste handling regulations. Please be sure to deliver wasted inverters and packing materials to certain site, which can assist relevant department to dispose and recycle.

79



Compliance Evaluation Report



REPORT No.: CSSC/BOS/005

ISSUED DATE: March 9, 2023

APPENDIX B. X1 Series User Manual 0.6kW - 3.3kW. (Cont.)

Disclaimer

9 Disclaimer

This limited warranty applies to products sold after date of 1st Jan 2022, and sold through our company or authorized resellers. The defective parts or units replaced under a warranty claim become our properties, and must be returned to us or Authorized Cooperated Partners (distributors) for inspection with the original or equivalent packaging.

The product is not covered by warranty in the following cases:

- A.The product is out of the warranty period;
- B.Product failure is not reported to us within one month of appearance;
- C.Failed to comply with our installation manual or maintenance instructions for the inverter or accessory;
- D.Failed to comply with the safety rules and regulations in respect of the inverter or accessory;
- E.The inverter or accessory is damaged during transportation but the claimant has signed the delivery receipt (which requests the claimant to double check the outside & inside of the package and take pictures as evidence before signing the delivery receipt);
- F.The replaced products have not been returned to us or cooperated partners (distributors) within 30 days;
- G.The defect is caused by improper usage of the product or failure to comply with the usage of the product for purposes other than those for which the product was designed or intended;
- H.The product is moved for any reason after it has been installed (regardless of whether it has been reinstalled subsequently or moved back to the same location) unless it is reinstalled at the same address by a qualified installer who has provided a test report to our company.
- I.The damage or defect is caused by lightning, flood, fire, power surge, corrosion, pest damage, actions of a third-party, or any other force majeure factors;
- J.The damage or defect is caused by embedded or external software or hardware (eg. the devices to control the inverters or the devices to control battery charging or discharging) from third

80

Commissioning

parties without authorization (agreement in writing) from our company;

K.The product is modified or altered (including the cases in which the product series number or product label is altered, removed, or defaced);

L.Flaws (eg. any external scratch or stain, or nature material wearing which does not represent a defect) that do not adversely affect the proper functioning of the inverter or accessory

M.Normal wear or tear;

N.Travel and subsistence expenses as well as on-site installation, modification and normal maintenance costs;

O.Duties, import/export fees or costs and other general administrative costs;

The substitute inverter or accessory with technical improvement may not be entirely compatible with the remaining components of the photovoltaic system. The costs incurred as a consequence will not be covered by the warranty or extended warranty.

Furthermore, all other costs including but not limited to compensation from direct or indirect damages arising from the defective device or other facilities of the PV system, or loss of power generated during the product downtime are not covered by this warranty. In any other case, whether in contract, tort, or otherwise, the maximum compensation for customer losses caused by its faults shall not exceed the amount paid by the customer for the purchase of the equipment.

81



Compliance Evaluation Report



REPORT No.: CSSC/BOS/005

ISSUED DATE: March 9, 2023

APPENDIX B. X1 Series User Manual 0.6kW - 3.3kW. (Cont.)

Warranty Registration Form



For Customer (Compulsory)

Name Country

Phone Number Email

Address

State Zip Code

Product Serial Number

Date of Commissioning

Installation Company Name

Installer Name Electrician License No.

For Installer

Module (If Any)

Module Brand

Module Size(W)

Number of String Number of Panel Per String

Battery (If Any)

Battery Type

Brand

Number of Battery Attached

Date of Delivery Signature

Please visit our warranty website: <https://www.solaxcloud.com/#/warranty> to complete the online warranty registration or use your mobile phone to scan the QR code to register.

For more detailed warranty terms, please visit Solax official website: www.solaxpower.com to check it.





Compliance Evaluation Report



REPORT No.: CSSC/BOS/005

ISSUED DATE: March 9, 2023

APPENDIX B. X1 Series User Manual 0.6kW - 3.3kW. (Cont.)



PLEASE REGISTER THE WARRANTY IMMEDIATELY AFTER INSTALLATION! GET YOUR WARRANTY CERTIFICATE FROM SOLAX! KEEP YOUR INVERTER ONLINE & WIN SOLAX POINTS!



This report is digitally signed only on the first page and does not need to be signed on all pages.



Compliance Evaluation Report



REPORT No.: CSSC/BOS/005

ISSUED DATE: March 9, 2023

APPENDIX C. TÜV Rheinland's Report No: CN23Y4BO 001.

Test Data / Test Plan		TÜVRheinland®	
TÜV Rheinland (Shanghai) Co., Ltd.		Document No.: TD-0189	
Protection and Control requirements for PEA Interface of Inverter based Generation Systems 2016.08		Report No:	CN23Y4BO 001
Order No. :	244466490	Product:	Grid-Connected PV Inverter
Client Name :	SolaX Power Network Technology (Zhejiang) Co., Ltd.	Model designation:	X1-MINI-1.5K-G4
Issue Date:	24.02.2023	Project Engineer:	Allen Hu
Lab Target:	TÜV Rheinland (Shanghai) Co., Ltd	Signature:	Allen Hu

Electrical rating of the equipment:	
Rated Input:	See appended rating label
Rated Output:	See appended rating label for more detail.
Firmware version:	Master:1.00,Manager:1.00
Phase:	<input checked="" type="checkbox"/> Single-phase <input type="checkbox"/> Three-phase
Protection class:	<input type="checkbox"/> Class 0 <input checked="" type="checkbox"/> Class I <input type="checkbox"/> Class II <input type="checkbox"/> Class III
Overvoltage Category(OVC):	<input type="checkbox"/> OVC I <input checked="" type="checkbox"/> OVC II (PV) <input checked="" type="checkbox"/> OVC III (Mains) <input type="checkbox"/> OVC IV
Pollution degree (PD):	<input type="checkbox"/> PD 1 <input checked="" type="checkbox"/> PD 2 (Inside) <input checked="" type="checkbox"/> PD 3 (Outside)
Max. operating temperature:	See appended rating label

Documents attached:	Remark
<input checked="" type="checkbox"/> Rating label	See following page.
<input checked="" type="checkbox"/> Product photo	See attachment 3.
<input checked="" type="checkbox"/> Test equipment list	See attachment 2.
<input checked="" type="checkbox"/> Wave diagram in test	See attachment 1.

Used equipment No.: See equipment list for details Sample No.: N/A
 Finished date: _____ Tested by: _____
 Review date: _____ Reviewed by: _____



Compliance Evaluation Report



REPORT No.: CSSC/BOS/005

ISSUED DATE: March 9, 2023

APPENDIX C. TÜV Rheinland's Report No: CN23Y4BO 001. (Cont.)

Test Data / Test Plan			
TÜV Rheinland (Shanghai) Co., Ltd.		Document No.: TD-0189	
Protection and Control requirements for PEA Interface of Inverter based Generation Systems 2016.08		Report No:	CN23Y4BO 001
Order No. :	244466490	Product:	Grid-Connected PV Inverter
Client Name :	SolaX Power Network Technology (Zhejiang) Co., Ltd.	Model designation:	X1-MINI-1.5K-G4

Content	Page No.
Rating label of EUT	4
General requirements and information for the tests	5
Requirements to the Measurement Precision of the Measuring Devices	8
Test results	10
Flicker	10
DC injection	11
Reactive Power Control	12
A Fixed Displacement Factor $\cos\phi$	13
Islanding Protection	15
Response to utility recovery	22
Over/Under voltage	23
Harmonic and waveform distortion	25
Over/Under Frequency	29
Active power control	30
Attachment 1: Wave result	31
Islanding Protection	31
Response to utility recovery	81
Over Voltage Protection	93
Under Voltage Protection	97
Over Frequency Protection	101
Under Frequency Protection	102
Remark for wave diagram	103
DC Current Trend Line	104

Used equipment No.: See equipment list for details Sample No.: N/A
 Finished date: _____ Tested by: _____
 Review date: _____ Reviewed by: _____



Compliance Evaluation Report



REPORT No.: CSSC/BOS/005

ISSUED DATE: March 9, 2023

APPENDIX C. TÜV Rheinland's Report No: CN23Y4BO 001. (Cont.)

Test Data / Test Plan		 TÜVRheinland®	
TÜV Rheinland (Shanghai) Co., Ltd.		Document No.: TD-0189	
Protection and Control requirements for PEA Interface of Inverter based Generation Systems 2016.08		Report No:	CN23Y4BO 001
Order No. :	244466490	Product:	Grid-Connected PV Inverter
Client Name :	SolaX Power Network Technology (Zhejiang) Co., Ltd.	Model designation:	X1-MINI-1.5K-G4

Content	Page No.
Active power control trend line	105
Attachment 2: Test equipment list	106
Attachment 3: EUT photo	107

Used equipment No.: See equipment list for details Sample No.: N/A

Finished date: _____ Tested by: _____

Review date: _____ Reviewed by: _____



Compliance Evaluation Report



REPORT No.: CSSC/BOS/005

ISSUED DATE: March 9, 2023

APPENDIX C. TÜV Rheinland's Report No: CN23Y4BO 001. (Cont.)

Test Data / Test Plan		TÜVRheinland®	
TÜV Rheinland (Shanghai) Co., Ltd.		Document No.: TD-0189	
Protection and Control requirements for PEA Interface of Inverter based Generation Systems 2016.08		Report No:	CN23Y4BO 001
Order No. :	244466490	Product:	Grid-Connected PV Inverter
Client Name :	SolaX Power Network Technology (Zhejiang) Co., Ltd.	Model designation:	X1-MINI-1.5K-G4

Copy of marking plate: "The artwork below may be only a draft. The use of certification marks on a product must be authorized by the respective NCB's that own these marks"

GRID-CONNECTED PHOTOVOLTAIC INVERTER Model: X1-MINI-1.5K-G4 Inverter SN:	
Max. PV Voltage	450 d.c. V
MPPV Voltage Range	40-450 d.c. V
Max. PV Current	16 d.c. A
Isc PV Array Short Circuit Current	22 d.c. A
Nominal AC Voltage, Frequency	220/230/0±0±0.5% V 50/60 Hz
Rated Output Current	6.5 a.c. A
Max. Output Continuous Current	7.5 a.c. A
Rated Output Apparent Power	3500 VA
Max. Output Apparent Power	3650 VA
Power Factor Range	0.8(leading)-0.8(lagging)
OTHERS	
Operating Ambient Temperature Range	-25°C to +50°C
Ingress Protection	IP66
Protection Class	I
Overvoltage Category	II (MANS, II/DC)
Inverter Topology	Non-isolated
Safety	IEC/EN 62109-1/-2
EMC	EN55011, EN60904-1-1/2/3/4, EN55020-3-2/3/1/1/2
Grid Monitoring	IEC61771, EN60943 GRS, AS 4777.2, IEC61851, CB 0-B, V18
DEAD DEAD1 DEAD2 DEAD3 DEAD4 DEAD5 DEAD6 DEAD7 DEAD8 <input type="checkbox"/> <input type="checkbox"/> <input type="checkbox"/> <input type="checkbox"/> <input type="checkbox"/> <input type="checkbox"/> <input type="checkbox"/> <input type="checkbox"/>	
For AC/DC 4777.2, the Rated Current is equivalent to the Max. Current.	
SolaX Power Network Technology (Zhejiang) Co., Ltd. ADD: No. 288, Shulin Road, Tongpu Economic Development Zone, Tongpu City, Zhejiang Province, 320000 P.R.CHINA TEL.: +86 (0) 571 56216 9011 E-mail: info@solarpower.com www.solarpower.com	
MADE IN CHINA 3203031105-08	

Used equipment No.: See equipment list for details Sample No.: N/A
 Finished date: _____ Tested by: _____
 Review date: _____ Reviewed by: _____



Compliance Evaluation Report



REPORT No.: CSSC/BOS/005

ISSUED DATE: March 9, 2023

APPENDIX C. TÜV Rheinland's Report No: CN23Y4BO 001. (Cont.)

Test Data / Test Plan			
TÜV Rheinland (Shanghai) Co., Ltd.		Document No.: TD-0189	
Protection and Control requirements for PEA Interface of Inverter based Generation Systems 2016.08		Report No:	CN23Y4BO 001
Order No. :	244466490	Product:	Grid-Connected PV Inverter
Client Name :	SolaX Power Network Technology (Zhejiang) Co., Ltd.	Model designation:	X1-MINI-1.5K-G4

Clause	Test description	Remark	Result
<input checked="" type="checkbox"/> 1.	Voltage and Frequency	Rating Voltage: AC 220/230V Rating Frequency: 50/60Hz	Pass
<input checked="" type="checkbox"/> 2.	Normal Voltage Operating Range	The EUT ¹⁾ can run normally within voltage range $\pm 5\%U_n$.	Pass
<input checked="" type="checkbox"/> 3.	Normal Frequency Operating Range	The EUT ¹⁾ can run normally within frequency range $\pm 0.5\text{Hz}$.	Pass
<input checked="" type="checkbox"/> 4.	Flicker	See appended table 4 for details.	Pass
<input checked="" type="checkbox"/> 5.	DC Injection	See appended table 5 for details.	Pass
<input checked="" type="checkbox"/> 6.	Reactive Power Control	See appended table 6 for details.	Pass
<input checked="" type="checkbox"/> 6.1	A Fixed Displacement Factor $\cos\phi$	See appended table 6.1 for details.	Pass
<input checked="" type="checkbox"/> 7.	Islanding Protection	See appended table 7 for details.	Pass
<input checked="" type="checkbox"/> 8.	Response to utility recovery	See appended table 8 for details.	Pass
<input checked="" type="checkbox"/> 9.	Over/Under voltage	See appended table 9 for details.	Pass
<input checked="" type="checkbox"/> 10.	Harmonic and waveform distortion	See appended table 10 for details.	Pass
<input checked="" type="checkbox"/> 11.	Over/Under Frequency	See appended table 11 for details.	Pass
<input checked="" type="checkbox"/> 12.	Active Power Control	See appended table 12 for details.	Pass
<input checked="" type="checkbox"/> 15.	Earthing	Protective equipotential bonding conductors are installed, where they are parallel to and in close contact with d.c. cables and a.c. cables and accessories.	Pass
<input checked="" type="checkbox"/> 16.	Short circuit	Circuit breakers should be installed at the connection to the designated distribution board of the electrical installation to protect the PV a.c.	Pass

Used equipment No.: See equipment list for details Sample No.: N/A
 Finished date: _____ Tested by: _____
 Review date: _____ Reviewed by: _____



Compliance Evaluation Report



REPORT No.: CSSC/BOS/005

ISSUED DATE: March 9, 2023

APPENDIX C. TÜV Rheinland's Report No: CN23Y4BO 001. (Cont.)

Test Data / Test Plan		TÜVRheinland®																			
TÜV Rheinland (Shanghai) Co., Ltd.		Document No.: TD-0189																			
Protection and Control requirements for PEA Interface of Inverter based Generation Systems 2016.08		Report No:	CN23Y4BO 001																		
Order No. :	244466490	Product:	Grid-Connected PV Inverter																		
Client Name :	SolaX Power Network Technology (Zhejiang) Co., Ltd.	Model designation:	X1-MINI-1.5K-G4																		
		supply cable from the effects of short circuit.																			
<input checked="" type="checkbox"/>	17. Isolating and switching	Switch disconnecter and a.c. relay are provided on the d.c. side and a.c. side of the PV inverter respectively.	Pass																		
<input checked="" type="checkbox"/>	18. Inverter Testing Procedure/Method	Test methods in below table are all complied.	Pass																		
<table border="1" style="width: 100%; border-collapse: collapse;"> <thead> <tr> <th>Item</th> <th>Testing Procedure/Method</th> </tr> </thead> <tbody> <tr> <td>Reference and standards description</td> <td>IEC 61800-3-2/IEC 61800-5-2/EN 62109-2-2</td> </tr> <tr> <td>Wiring</td> <td>IEC 61800-5-2/IEC 61800-5-1/EN 61800-5-1</td> </tr> <tr> <td>DC Injection</td> <td>IEC / Lab-design</td> </tr> <tr> <td>Over/Under voltage</td> <td>IEC / Lab-design</td> </tr> <tr> <td>Over/Under frequency</td> <td>IEC / Lab-design</td> </tr> <tr> <td>Unloading Protection</td> <td>IEC 61800-5-2</td> </tr> <tr> <td>Temperature stability protection</td> <td>IEC / Lab-design</td> </tr> <tr> <td>Power Factor Control</td> <td>IEC / Lab-design</td> </tr> </tbody> </table>				Item	Testing Procedure/Method	Reference and standards description	IEC 61800-3-2/IEC 61800-5-2/EN 62109-2-2	Wiring	IEC 61800-5-2/IEC 61800-5-1/EN 61800-5-1	DC Injection	IEC / Lab-design	Over/Under voltage	IEC / Lab-design	Over/Under frequency	IEC / Lab-design	Unloading Protection	IEC 61800-5-2	Temperature stability protection	IEC / Lab-design	Power Factor Control	IEC / Lab-design
Item	Testing Procedure/Method																				
Reference and standards description	IEC 61800-3-2/IEC 61800-5-2/EN 62109-2-2																				
Wiring	IEC 61800-5-2/IEC 61800-5-1/EN 61800-5-1																				
DC Injection	IEC / Lab-design																				
Over/Under voltage	IEC / Lab-design																				
Over/Under frequency	IEC / Lab-design																				
Unloading Protection	IEC 61800-5-2																				
Temperature stability protection	IEC / Lab-design																				
Power Factor Control	IEC / Lab-design																				
Remark: The product is only intended for the system capacity less than 500kW.																					

Revision History:

Date YYYY-MM-DD	Contents of modification	Prepared by	Approved by
2016-03-31	Original Test Plan	Tobias Yang	Li Weichun
2016-08-01	Modified Test Plan	Tobias Yang	Li Weichun

Used equipment No.: See equipment list for details Sample No.: N/A
 Finished date: _____ Tested by: _____
 Review date: _____ Reviewed by: _____



Compliance Evaluation Report



REPORT No.: CSSC/BOS/005

ISSUED DATE: March 9, 2023

APPENDIX C. TÜV Rheinland's Report No: CN23Y4BO 001. (Cont.)

Test Data / Test Plan			
TÜV Rheinland (Shanghai) Co., Ltd.		Document No.: TD-0189	
Protection and Control requirements for PEA Interface of Inverter based Generation Systems 2016.08		Report No:	CN23Y4BO 001
Order No. :	244466490	Product:	Grid-Connected PV Inverter
Client Name :	SolaX Power Network Technology (Zhejiang) Co., Ltd.	Model designation:	X1-MINI-1.5K-G4

Special notice to test engineer

Please contact and communicate with project engineer immediately when any of the following conditions occurred:

- Unclear of the test operating conditions and test items,
- Uncertain of the test requirements or possible typing errors found in the test plan,
- Unusual operating conditions of the EUT (unusual noises, unstable operation, ...etc), any unusual phenomenon of the operation that attracts your attention,
- Receive different model/type name of samples that does not match to the test plan,
- Short of the test samples,
- Unusual high temperatures observed during testing,
- Enclosure distortion, cracks, or loosening of any enclosure parts observed during testing, and
- Fire occurred within the EUT during testing

Handling of test samples after completed all tests:

- Store in warehouse and wait for further notice
- Return to project engineer
- Dispose test samples according to current lab procedures
- Return to the client

Used equipment No.: See equipment list for details Sample No.: N/A

Finished date: _____ Tested by: _____

Review date: _____ Reviewed by: _____



Compliance Evaluation Report



REPORT No.: CSSC/BOS/005

ISSUED DATE: March 9, 2023

APPENDIX C. TÜV Rheinland's Report No: CN23Y4BO 001. (Cont.)

Test Data / Test Plan			
TÜV Rheinland (Shanghai) Co., Ltd.		Document No.: TD-0189	
Protection and Control requirements for PEA Interface of Inverter based Generation Systems 2016.08		Report No:	CN23Y4BO 001
Order No. :	244466490	Product:	Grid-Connected PV Inverter
Client Name :	SolaX Power Network Technology (Zhejiang) Co., Ltd.	Model designation:	X1-MINI-1.5K-G4

Requirements to the Measurement Precision of the Measuring Devices

The used measuring devices must fulfill at least the following measuring precisions.

Minimum measuring precisions

Measured Variable	Frequency Range	Measuring Precision relative to the Measuring Range
Voltage up to 1 000 V	50 Hz	± 0.1 %
	DC to 1 kHz (except for 50 Hz)	± 1.0 %
	1 kHz to < 5 kHz	± 1.5 %
	5 kHz to < 20 kHz	± 2.5 %
	≥ 20 kHz	± 5.0 %
Current < 5A Current > 5A	50 Hz	± 0.5 %
	DC to < 60 Hz (except for 50 Hz)	± 1.0 %
	60 Hz to < 5 kHz	± 1.5 %
	5 kHz to < 20 kHz	± 2.5 %
	50 Hz	± 0.5 %
	≥ 20 kHz (except for 50 Hz)	± 5.0 %
Frequency	DC to < 60 Hz	± 0.01 Hz
	60 Hz to 5 kHz	± 0.2 %
	5 kHz to < 20 kHz	± 0.5 %
	≥ 20 kHz	± 1 %
Displacement Factor cos φ		0.001
Time	10 ms to < 200 ms	± 5 % of the measured value
	200 ms to < 1 s	± 10 ms
	≥ 1 s	± 1 % of the measured value
Temperature	> -35°C to 100°C	± 2°C

Used equipment No.: See equipment list for details Sample No.: N/A
 Finished date: _____ Tested by: _____
 Review date: _____ Reviewed by: _____



Compliance Evaluation Report



REPORT No.: CSSC/BOS/005

ISSUED DATE: March 9, 2023

APPENDIX C. TÜV Rheinland's Report No: CN23Y4BO 001. (Cont.)

Test Data / Test Plan		TÜVRheinland®	
TÜV Rheinland (Shanghai) Co., Ltd.		Document No.: TD-0189	
Protection and Control requirements for PEA Interface of Inverter based Generation Systems 2016.08		Report No:	CN23Y4BO 001
Order No. :	244466490	Product:	Grid-Connected PV Inverter
Client Name :	SolaX Power Network Technology (Zhejiang) Co., Ltd.	Model designation:	X1-MINI-1.5K-G4

Measured Variable	Frequency Range	Measuring Precision relative to the Measuring Range
Relative humidity	30 % to 95 % RH	± 6 % RH
Barometric air pressure		± 10 kPa

The selected measuring range must not be bigger than 150% of the nominal value of the signal to be measured.

Source: CTL Decision Sheet DHS251B / 2009, modified

Used equipment No.: See equipment list for details Sample No.: N/A
 Finished date: _____ Tested by: _____
 Review date: _____ Reviewed by: _____



Compliance Evaluation Report



REPORT No.: CSSC/BOS/005

ISSUED DATE: March 9, 2023

APPENDIX C. TÜV Rheinland's Report No: CN23Y4BO 001. (Cont.)

Test Data / Test Plan		TÜVRheinland®	
TÜV Rheinland (Shanghai) Co., Ltd.		Document No.: TD-0189	
Protection and Control requirements for PEA Interface of Inverter based Generation Systems 2016.08		Report No:	CN23Y4BO 001
Order No. :	244466490	Product:	Grid-Connected PV Inverter
Client Name :	SolaX Power Network Technology (Zhejiang) Co., Ltd.	Model designation:	X1-MINI-1.5K-G4

4. Flicker

PROCEDURE

Test method complies with standard IEC 61000-3-3 or IEC 61000-3-11.

RESULTS Pass / Fail

4		TABLE: Flicker			
Mains voltage: 220V					
Reference Impedance used:		L=0.25+0.25j, N=0.1+0.1j			
Measurement	P _{fl}	0.01			
	Limit	0.65			
	P _{st}	dc(%)	d _{max} (%)	d(t) (ms)	
	Limit= 1.0	Limit= 3.3	Limit= 4.0	Limit= 500	
Phase A	1	0.01	0.00	0.49	0.00
	2	0.01	0.00	0.49	0.00
	3	0.01	0.00	0.49	0.00
	4	0.01	0.00	0.49	0.00
	5	0.01	0.00	0.49	0.00
	6	0.01	0.00	0.49	0.00
	7	0.01	0.00	0.49	0.00
	8	0.01	0.00	0.49	0.00
	9	0.01	0.00	0.49	0.00
	10	0.01	0.00	0.49	0.00
	11	0.01	0.00	0.49	0.00
	12	0.01	0.00	0.49	0.00

Used equipment No.: See equipment list for details Sample No.: N/A
 Finished date: _____ Tested by: _____
 Review date: _____ Reviewed by: _____



Compliance Evaluation Report



REPORT No.: CSSC/BOS/005

ISSUED DATE: March 9, 2023

APPENDIX C. TÜV Rheinland's Report No: CN23Y4BO 001. (Cont.)

Test Data / Test Plan		TÜVRheinland®	
TÜV Rheinland (Shanghai) Co., Ltd.		Document No.: TD-0189	
Protection and Control requirements for PEA Interface of Inverter based Generation Systems 2016.08		Report No:	CN23Y4BO 001
Order No. :	244466490	Product:	Grid-Connected PV Inverter
Client Name :	SolaX Power Network Technology (Zhejiang) Co., Ltd.	Model designation:	X1-MINI-1.5K-G4

5. DC Injection

PROCEDURE

The test methods complies with standard IEEE 1547.1-2005 clause 5.6

RESULTS Pass / Fail

5	TABLE: DC Injection							
Mains voltage: 220 V								
PowerP/Pn[%]		100%						
Measurement							Limit	
Phase A		Phase B		Phase C				
[A]	[%]	[A]	[%]	[A]	[%]	[A]	[%]	
0.001	0.015	--	--	--	--	0.034	0.5	
PowerP/Pn[%]		66%						
Measurement							Limit	
Phase A		Phase B		Phase C				
[A]	[%]	[A]	[%]	[A]	[%]	[A]	[%]	
0.001	0.015	--	--	--	--	0.034	0.5	
PowerP/Pn[%]		33%						
Measurement							Limit	
Phase A		Phase B		Phase C				
[A]	[%]	[A]	[%]	[A]	[%]	[A]	[%]	
0.001	0.015	--	--	--	--	0.034	0.5	
Remark: The absolute value of dc current was taken.								

Used equipment No.: See equipment list for details Sample No.: N/A
 Finished date: _____ Tested by: _____
 Review date: _____ Reviewed by: _____



Compliance Evaluation Report



REPORT No.: CSSC/BOS/005

ISSUED DATE: March 9, 2023

APPENDIX C. TÜV Rheinland's Report No: CN23Y4BO 001. (Cont.)

Test Data / Test Plan			
TÜV Rheinland (Shanghai) Co., Ltd.		Document No.: TD-0189	
Protection and Control requirements for PEA Interface of Inverter based Generation Systems 2016.08		Report No:	CN23Y4BO 001
Order No. :	244466490	Product:	Grid-Connected PV Inverter
Client Name :	SolaX Power Network Technology (Zhejiang) Co., Ltd.	Model designation:	X1-MINI-1.5K-G4

6. Reactive Power Control

PROCEDURE

The test methods complies with standard Protection and Control requirements for PEA Interface of Inverter based Generation Systems 2016.08

RESULTS Pass / Fail

6.	TABLE: Power Factor Control						
Mains voltage: 220V							
P Set value	P [W]	Cosφ Max. lagging	Q [Var]	P Set value	P [W]	Cosφ Max. leading	Q [Var]
0%	54.9	0.109	-502.1	0%	65.8	0.132	492.7
10%	155.2	0.301	-501.9	10%	155.3	0.300	493.5
20%	307.0	0.522	-501.6	20%	308.8	0.530	494.2
30%	448.2	0.666	-501.5	30%	451.7	0.674	494.5
40%	624.2	0.780	-501.2	40%	636.6	0.785	494.9
50%	766.4	0.837	-500.8	50%	766.4	0.840	495.2
60%	942.1	0.883	-500.5	60%	942.2	0.885	495.8
70%	1080.2	0.907	-500.3	70%	1220.3	0.926	495.9
80%	1220.1	0.925	-500.0	80%	1184.5	0.922	495.9
90%	1358.1	0.938	-500.1	90%	1358.0	0.939	496.2
100%	1528.1	0.950	-500.0	100%	1529.9	0.950	496.5

Used equipment No.: See equipment list for details Sample No.: N/A
 Finished date: _____ Tested by: _____
 Review date: _____ Reviewed by: _____



Compliance Evaluation Report



REPORT No.: CSSC/BOS/005

ISSUED DATE: March 9, 2023

APPENDIX C. TÜV Rheinland's Report No: CN23Y4BO 001. (Cont.)

Test Data / Test Plan			
TÜV Rheinland (Shanghai) Co., Ltd.		Document No.: TD-0189	
Protection and Control requirements for PEA Interface of Inverter based Generation Systems 2016.08		Report No:	CN23Y4BO 001
Order No. :	244466490	Product:	Grid-Connected PV Inverter
Client Name :	SolaX Power Network Technology (Zhejiang) Co., Ltd.	Model designation:	X1-MINI-1.5K-G4

6.1. A fixed displacement factor cosØ

PROCEDURE

The test methods complies with standard Protection and Control requirements for PEA Interface of Inverter based Generation Systems 2016.08

6.1	TABLE: Power Factor Control							
Mains voltage: 220V								
P Set value	CosØ Set value	P [W]	Q [Var]	CosØ	CosØ Set value	P [W]	Q [Var]	CosØ
0%	0.95 lagging	72.8	-29.2	0.919	0.95 leading	60.6	16.2	0.966
10%	0.95 lagging	150.6	-51.7	0.946	0.95 leading	155.7	41.4	0.950
20%	0.95 lagging	312.0	-101.7	0.946	0.95 leading	311.8	99.5	0.950
30%	0.95 lagging	454.8	-152.7	0.949	0.95 leading	452.4	147.4	0.949
40%	0.95 lagging	631.4	-209.9	0.949	0.95 leading	628.0	206.1	0.950
50%	0.95 lagging	772.1	-255.7	0.949	0.95 leading	767.3	252.6	0.950
60%	0.95 lagging	942.3	-311.2	0.950	0.95 leading	944.3	312.0	0.950
70%	0.95 lagging	1081.3	-356.6	0.950	0.95 leading	1081.7	358.0	0.950
80%	0.95 lagging	1219.8	-402.0	0.950	0.95 leading	1219.8	404.3	0.949
90%	0.95 lagging	1358.7	-447.3	0.950	0.95 leading	1357.4	450.4	0.949
100%	0.95 lagging	1528.7	-503.7	0.950	0.95 leading	1528.7	507.8	0.949

Used equipment No.: See equipment list for details Sample No.: N/A
 Finished date: _____ Tested by: _____
 Review date: _____ Reviewed by: _____



Compliance Evaluation Report



REPORT No.: CSSC/BOS/005

ISSUED DATE: March 9, 2023

APPENDIX C. TÜV Rheinland's Report No: CN23Y4BO 001. (Cont.)

Test Data / Test Plan			
TÜV Rheinland (Shanghai) Co., Ltd.		Document No.: TD-0189	
Protection and Control requirements for PEA Interface of Inverter based Generation Systems 2016.08		Report No:	CN23Y4BO 001
Order No. :	244466490	Product:	Grid-Connected PV Inverter
Client Name :	SolaX Power Network Technology (Zhejiang) Co., Ltd.	Model designation:	X1-MINI-1.5K-G4

P Set value	Cosφ Set value	P [W]	Q [Var]	Cosφ				
0%	1.00	71.4	-12.9	0.986				
10%	1.00	150.5	-11.4	0.996				
20%	1.00	311.8	-10.5	0.999				
30%	1.00	453.0	-10.8	0.999				
40%	1.00	628.2	-9.5	0.999				
50%	1.00	768.2	-8.9	0.999				
60%	1.00	942.8	-8.6	0.999				
70%	1.00	1082.0	-8.1	0.999				
80%	1.00	1220.8	-7.8	0.999				
90%	1.00	1359.2	-7.5	0.999				
100%	1.00	1531.0	-7.2	0.999				

Used equipment No.: See equipment list for details Sample No.: N/A

Finished date: _____ Tested by: _____

Review date: _____ Reviewed by: _____



Compliance Evaluation Report



REPORT No.: CSSC/BOS/005

ISSUED DATE: March 9, 2023

APPENDIX C. TÜV Rheinland's Report No: CN23Y4BO 001. (Cont.)

Test Data / Test Plan		TÜVRheinland®	
TÜV Rheinland (Shanghai) Co., Ltd.		Document No.: TD-0189	
Protection and Control requirements for PEA Interface of Inverter based Generation Systems 2016.08		Report No:	CN23Y4BO 001
Order No. :	244466490	Product:	Grid-Connected PV Inverter
Client Name :	SolaX Power Network Technology (Zhejiang) Co., Ltd.	Model designation:	X1-MINI-1.5K-G4

7. Islanding Protection

PROCEDURE

Test methods complies with standard IEC 62116.

RESULTS Pass / Fail

7	TABLE: Islanding Protection					
	Mains voltage: 220V					
Power 100%						
Conditions	P _w [W]	Q _L [Var]	Q _C [Var]	Q _r	Trip time [ms]	Limitation [ms]
P _R : -10% Q _C : +10%	L1: 1279	L1: 1500	L1: 1664	1.15	292ms	1000
	L2: --	L2: --	L2: --	--		
	L3: --	L3: --	L3: --	--		
P _R : -10% Q _C : +5%	L1: 1279	L1: 1500	L1: 1589	1.12	202ms	1000
	L2: --	L2: --	L2: --	--		
	L3: --	L3: --	L3: --	--		
P _R : -10% Q _C : 0%	L1: 1279	L1: 1500	L1: 1513	1.09	228ms	1000
	L2: --	L2: --	L2: --	--		
	L3: --	L3: --	L3: --	--		
P _R : -10% Q _C : -5%	L1: 1279	L1: 1500	L1: 1437	1.06	94ms	1000
	L2: --	L2: --	L2: --	--		
	L3: --	L3: --	L3: --	--		
P _R : -10% Q _C : -10%	L1: 1279	L1: 1500	L1: 1362	1.04	76ms	1000
	L2: --	L2: --	L2: --	--		
	L3: --	L3: --	L3: --	--		

Used equipment No.: See equipment list for details Sample No.: N/A
 Finished date: _____ Tested by: _____
 Review date: _____ Reviewed by: _____



Compliance Evaluation Report



REPORT No.: CSSC/BOS/005

ISSUED DATE: March 9, 2023

APPENDIX C. TÜV Rheinland's Report No: CN23Y4BO 001. (Cont.)

Test Data / Test Plan			
TÜV Rheinland (Shanghai) Co., Ltd.		Document No.: TD-0189	
Protection and Control requirements for PEA Interface of Inverter based Generation Systems 2016.08		Report No:	CN23Y4BO 001
Order No. :	244466490	Product:	Grid-Connected PV Inverter
Client Name :	SolaX Power Network Technology (Zhejiang) Co., Ltd.	Model designation:	X1-MINI-1.5K-G4

PR: -5% QC: +10%	L1: 1350	L1: 1500	L1: 1664	1.09	100ms	1000
	L2: --	L2: --	L2: --	--		
	L3: --	L3: --	L3: --	--		
PR: -5% QC: -10%	L1: 1350	L1: 1500	L1: 1362	0.98	84ms	1000
	L2: --	L2: --	L2: --	--		
	L3: --	L3: --	L3: --	--		
PR: 0% QC: +10%	L1: 1421	L1: 1500	L1: 1664	1.03	114ms	1000
	L2: --	L2: --	L2: --	--		
	L3: --	L3: --	L3: --	--		
PR: -5% QC: +5%	L1: 1350	L1: 1500	L1: 1589	1.07	124ms	1000
	L2: --	L2: --	L2: --	--		
	L3: --	L3: --	L3: --	--		
PR: -5% QC: 0%	L1: 1350	L1: 1500	L1: 1513	1.04	370ms	1000
	L2: --	L2: --	L2: --	--		
	L3: --	L3: --	L3: --	--		
PR: -5% QC: -5%	L1: 1350	L1: 1500	L1: 1437	1.01	110ms	1000
	L2: --	L2: --	L2: --	--		
	L3: --	L3: --	L3: --	--		
PR: 0% QC: +5%	L1: 1421	L1: 1500	L1: 1589	1.01	186ms	1000
	L2: --	L2: --	L2: --	--		
	L3: --	L3: --	L3: --	--		
PR: 0% QC: 0%	L1: 1421	L1: 1500	L1: 1513	0.99	302ms	1000
	L2: --	L2: --	L2: --	--		
	L3: --	L3: --	L3: --	--		

Used equipment No.: See equipment list for details Sample No.: N/A
 Finished date: _____ Tested by: _____
 Review date: _____ Reviewed by: _____



Compliance Evaluation Report



REPORT No.: CSSC/BOS/005

ISSUED DATE: March 9, 2023

APPENDIX C. TÜV Rheinland's Report No: CN23Y4BO 001. (Cont.)

Test Data / Test Plan		TÜVRheinland®	
TÜV Rheinland (Shanghai) Co., Ltd.		Document No.: TD-0189	
Protection and Control requirements for PEA Interface of Inverter based Generation Systems 2016.08		Report No:	CN23Y4BO 001
Order No. :	244466490	Product:	Grid-Connected PV Inverter
Client Name :	SolaX Power Network Technology (Zhejiang) Co., Ltd.	Model designation:	X1-MINI-1.5K-G4

PR: 0% QC: -5%	L1: 1421	L1: 1500	L1: 1437	0.97	98ms	1000
	L2: --	L2: --	L2: --	--		
	L3: --	L3: --	L3: --	--		
PR: +5% QC: +5%	L1: 1492	L1: 1500	L1: 1589	0.97	138ms	1000
	L2: --	L2: --	L2: --	--		
	L3: --	L3: --	L3: --	--		
PR: +5% QC: 0%	L1: 1492	L1: 1500	L1: 1513	0.95	422ms	1000
	L2: --	L2: --	L2: --	--		
	L3: --	L3: --	L3: --	--		
PR: +5% QC: -5%	L1: 1492	L1: 1500	L1: 1437	0.92	114ms	1000
	L2: --	L2: --	L2: --	--		
	L3: --	L3: --	L3: --	--		
PR: 0% QC: -10%	L1: 1421	L1: 1500	L1: 1362	0.94	102ms	1000
	L2: --	L2: --	L2: --	--		
	L3: --	L3: --	L3: --	--		
PR: +5% QC: +10%	L1: 1492	L1: 1500	L1: 1664	0.99	118ms	1000
	L2: --	L2: --	L2: --	--		
	L3: --	L3: --	L3: --	--		
PR: +5% QC: -10%	L1: 1492	L1: 1500	L1: 1362	0.90	90ms	1000
	L2: --	L2: --	L2: --	--		
	L3: --	L3: --	L3: --	--		
PR: +10% QC: +10%	L1: 1563	L1: 1500	L1: 1664	0.95	114ms	1000
	L2: --	L2: --	L2: --	--		
	L3: --	L3: --	L3: --	--		

Used equipment No.: See equipment list for details Sample No.: N/A

Finished date: _____ Tested by: _____

Review date: _____ Reviewed by: _____



Compliance Evaluation Report



REPORT No.: CSSC/BOS/005

ISSUED DATE: March 9, 2023

APPENDIX C. TÜV Rheinland's Report No: CN23Y4BO 001. (Cont.)

Test Data / Test Plan		TÜVRheinland®	
TÜV Rheinland (Shanghai) Co., Ltd.		Document No.: TD-0189	
Protection and Control requirements for PEA Interface of Inverter based Generation Systems 2016.08		Report No:	CN23Y4BO 001
Order No. :	244466490	Product:	Grid-Connected PV Inverter
Client Name :	SolaX Power Network Technology (Zhejiang) Co., Ltd.	Model designation:	X1-MINI-1.5K-G4

PR: +10% QC: +5%	L1: 1563	L1: 1500	L1: 1589	0.92	210ms	1000
	L2: --	L2: --	L2: --	--		
	L3: --	L3: --	L3: --	--		
PR: +10% QC: 0%	L1: 1563	L1: 1500	L1: 1513	0.90	314ms	1000
	L2: --	L2: --	L2: --	--		
	L3: --	L3: --	L3: --	--		
PR: 10% QC: -5%	L1: 1563	L1: 1500	L1: 1437	0.88	88ms	1000
	L2: --	L2: --	L2: --	--		
	L3: --	L3: --	L3: --	--		
PR: +10% QC: -10%	L1: 1563	L1: 1500	L1: 1362	0.86	78ms	1000
	L2: --	L2: --	L2: --	--		
	L3: --	L3: --	L3: --	--		
Power 66%						
Conditions	P _w [W]	Q _c [VA]	Q _c [VA]	Q _r	Trip time [ms]	Limitation [ms]
PR: 0% QC: -5%	L1: 932	L1: 990	L1: 953	0.96	132ms	1000
	L2: --	L2: --	L2: --	--		
	L3: --	L3: --	L3: --	--		
PR: 0% QC: -4%	L1: 932	L1: 990	L1: 963	0.97	146ms	1000
	L2: --	L2: --	L2: --	--		
	L3: --	L3: --	L3: --	--		
PR: 0% QC: -3%	L1: 932	L1: 990	L1: 973	0.97	286ms	1000
	L2: --	L2: --	L2: --	--		
	L3: --	L3: --	L3: --	--		
PR: 0%	L1: 932	L1: 990	L1: 983	0.98	138ms	

Used equipment No.: See equipment list for details Sample No.: N/A
 Finished date: _____ Tested by: _____
 Review date: _____ Reviewed by: _____



Compliance Evaluation Report



REPORT No.: CSSC/BOS/005

ISSUED DATE: March 9, 2023

APPENDIX C. TÜV Rheinland's Report No: CN23Y4BO 001. (Cont.)

Test Data / Test Plan		TÜVRheinland®	
TÜV Rheinland (Shanghai) Co., Ltd.		Document No.: TD-0189	
Protection and Control requirements for PEA Interface of Inverter based Generation Systems 2016.08		Report No:	CN23Y4BO 001
Order No. :	244466490	Product:	Grid-Connected PV Inverter
Client Name :	SolaX Power Network Technology (Zhejiang) Co., Ltd.	Model designation:	X1-MINI-1.5K-G4

Qc: -2%	L2: --	L2: --	L2: --	--	1000
	L3: --	L3: --	L3: --	--	
Pr: 0% Qc: -1%	L1: 932	L1: 990	L1: 993	0.99	212ms 1000
	L2: --	L2: --	L2: --	--	
	L3: --	L3: --	L3: --	--	
Pr: 0% Qc: 0%	L1: 932	L1: 990	L1: 1004	0.99	348ms 1000
	L2: --	L2: --	L2: --	--	
	L3: --	L3: --	L3: --	--	
Pr: 0% Qc: +1%	L1: 932	L1: 990	L1: 1014	1.00	294ms 1000
	L2: --	L2: --	L2: --	--	
	L3: --	L3: --	L3: --	--	
Pr: 0% Qc: +2%	L1: 932	L1: 990	L1: 1024	1.00	368ms 1000
	L2: --	L2: --	L2: --	--	
	L3: --	L3: --	L3: --	--	
Pr: 0% Qc: +3%	L1: 932	L1: 990	L1: 1034	1.00	262ms 1000
	L2: --	L2: --	L2: --	--	
	L3: --	L3: --	L3: --	--	
Pr: 0% Qc: +4%	L1: 932	L1: 990	L1: 1044	1.01	340ms 1000
	L2: --	L2: --	L2: --	--	
	L3: --	L3: --	L3: --	--	
Pr: 0% Qc: +5%	L1: 932	L1: 990	L1: 1054	1.01	252ms 1000
	L2: --	L2: --	L2: --	--	
	L3: --	L3: --	L3: --	--	
Power 33%					

Used equipment No.: See equipment list for details Sample No.: N/A
 Finished date: _____ Tested by: _____
 Review date: _____ Reviewed by: _____



Compliance Evaluation Report



REPORT No.: CSSC/BOS/005

ISSUED DATE: March 9, 2023

APPENDIX C. TÜV Rheinland's Report No: CN23Y4BO 001. (Cont.)

Test Data / Test Plan		TÜVRheinland®	
TÜV Rheinland (Shanghai) Co., Ltd.		Document No.: TD-0189	
Protection and Control requirements for PEA Interface of Inverter based Generation Systems 2016.08		Report No:	CN23Y4BO 001
Order No. :	244466490	Product:	Grid-Connected PV Inverter
Client Name :	SolaX Power Network Technology (Zhejiang) Co., Ltd.	Model designation:	X1-MINI-1.5K-G4

Conditions	P _w [kw]	Q _L [kVA]	Q _C [kVA]	Q _r	Trip time [ms]	Limitation [ms]
P _R : 0% Q _C : -5%	L1: 438	L1: 500	L1: 482	1.02	308ms	1000
	L2: --	L2: --	L2: --	--		
	L3: --	L3: --	L3: --	--		
P _R : 0% Q _C : -4%	L1: 438	L1: 500	L1: 487	1.02	310ms	1000
	L2: --	L2: --	L2: --	--		
	L3: --	L3: --	L3: --	--		
P _R : 0% Q _C : -3%	L1: 438	L1: 500	L1: 492	1.03	148ms	1000
	L2: --	L2: --	L2: --	--		
	L3: --	L3: --	L3: --	--		
P _R : 0% Q _C : -2%	L1: 438	L1: 500	L1: 497	1.03	138ms	1000
	L2: --	L2: --	L2: --	--		
	L3: --	L3: --	L3: --	--		
P _R : 0% Q _C : -1%	L1: 438	L1: 500	L1: 502	1.03	146ms	1000
	L2: --	L2: --	L2: --	--		
	L3: --	L3: --	L3: --	--		
P _R : 0% Q _C : 0%	L1: 438	L1: 500	L1: 508	1.05	342ms	1000
	L2: --	L2: --	L2: --	--		
	L3: --	L3: --	L3: --	--		
P _R : 0% Q _C : +1%	L1: 438	L1: 500	L1: 513	1.05	478ms	1000
	L2: --	L2: --	L2: --	--		
	L3: --	L3: --	L3: --	--		
P _R : 0% Q _C : +2%	L1: 438	L1: 500	L1: 518	1.05	388ms	1000
	L2: --	L2: --	L2: --	--		

Used equipment No.: See equipment list for details Sample No.: N/A
 Finished date: _____ Tested by: _____
 Review date: _____ Reviewed by: _____



Compliance Evaluation Report



REPORT No.: CSSC/BOS/005

ISSUED DATE: March 9, 2023

APPENDIX C. TÜV Rheinland's Report No: CN23Y4BO 001. (Cont.)

Test Data / Test Plan				TÜVRheinland®	
TÜV Rheinland (Shanghai) Co., Ltd.			Document No.: TD-0189		
Protection and Control requirements for PEA Interface of Inverter based Generation Systems 2016.08			Report No:	CN23Y4BO 001	
Order No. :	244466490		Product:	Grid-Connected PV Inverter	
Client Name :	SolaX Power Network Technology (Zhejiang) Co., Ltd.		Model designation:	X1-MINI-1.5K-G4	

	L3: --	L3: --	L3: --	--		
PR: 0% QC: +3%	L1: 438	L1: 500	L1: 523	1.06	358ms	1000
	L2: --	L2: --	L2: --	--		
	L3: --	L3: --	L3: --	--		
PR: 0% QC: +4%	L1: 438	L1: 500	L1: 528	1.06	360ms	1000
	L2: --	L2: --	L2: --	--		
	L3: --	L3: --	L3: --	--		
PR: 0% QC: +5%	L1: 438	L1: 500	L1: 533	1.07	352ms	1000
	L2: --	L2: --	L2: --	--		
	L3: --	L3: --	L3: --	--		
Remark:						

Used equipment No.: See equipment list for details Sample No.: N/A
 Finished date: _____ Tested by: _____
 Review date: _____ Reviewed by: _____



Compliance Evaluation Report



REPORT No.: CSSC/BOS/005

ISSUED DATE: March 9, 2023

APPENDIX C. TÜV Rheinland's Report No: CN23Y4BO 001. (Cont.)

Test Data / Test Plan		TÜVRheinland®	
TÜV Rheinland (Shanghai) Co., Ltd.		Document No.: TD-0189	
Protection and Control requirements for PEA Interface of Inverter based Generation Systems 2016.08		Report No:	CN23Y4BO 001
Order No. :	244466490	Product:	Grid-Connected PV Inverter
Client Name :	SolaX Power Network Technology (Zhejiang) Co., Ltd.	Model designation:	X1-MINI-1.5K-G4

8. Response to Utility Recovery

PROCEDURE

Test methods complies with standard IEEE 1547.1-2005, clause 5.10.

RESULTS Pass / Fail

4.3.7	TABLE: Response to Utility Recovery			
	Rated voltage U_n : 220V		Rated frequency F_n : 50Hz	
Voltage detection accuracy [V]	± 1		Frequency detection accuracy [Hz]	± 0.1
Specified recover voltage range	198-242V		Specified recover frequency range	47-52Hz
Recover time [s]	120			
Conditions ³⁾	U_M back to 244V	U_M back to 240V	U_M back to 196V	U_M back to 200V
Reconnection	<input type="checkbox"/> Yes/ <input checked="" type="checkbox"/> No	<input checked="" type="checkbox"/> Yes/ <input type="checkbox"/> No	<input type="checkbox"/> Yes/ <input checked="" type="checkbox"/> No	<input checked="" type="checkbox"/> Yes/ <input type="checkbox"/> No
Recover time [s]	N/A	127.9	N/A	126.9
Conditions ³⁾	F_M back to 52.2Hz	F_M back to 51.8 Hz	F_M back to 46.8Hz	F_M back to 47.2Hz
Reconnection	<input type="checkbox"/> Yes/ <input checked="" type="checkbox"/> No	<input checked="" type="checkbox"/> Yes/ <input type="checkbox"/> No	<input type="checkbox"/> Yes/ <input checked="" type="checkbox"/> No	<input checked="" type="checkbox"/> Yes/ <input type="checkbox"/> No
Recover time [s]	N/A	127.1	N/A	127.1
Conditions ⁴⁾	U_M back to 240V	U_M back to 200V	F_M back to 51.8Hz	F_M back to 47.2Hz
Reconnection	<input checked="" type="checkbox"/> Yes/ <input type="checkbox"/> No	<input checked="" type="checkbox"/> Yes/ <input type="checkbox"/> No	<input checked="" type="checkbox"/> Yes/ <input type="checkbox"/> No	<input checked="" type="checkbox"/> Yes/ <input type="checkbox"/> No
Recover time [s]	127.5	127.3	127.4	127.4
Remark: 1) U_M =Mains voltage; F_M =Mains frequency. 2) After mains voltage tripped the over/under voltage limit. 3) After mains voltage frequency tripped the over/under frequency limit. 4) Retest with an abnormal voltage/frequency change event that is introduced during the reconnect countdown period.				

Used equipment No.: See equipment list for details Sample No.: N/A
 Finished date: _____ Tested by: _____
 Review date: _____ Reviewed by: _____



Compliance Evaluation Report



REPORT No.: CSSC/BOS/005

ISSUED DATE: March 9, 2023

APPENDIX C. TÜV Rheinland's Report No: CN23Y4BO 001. (Cont.)

Test Data / Test Plan			
TÜV Rheinland (Shanghai) Co., Ltd.		Document No.: TD-0189	
Protection and Control requirements for PEA Interface of Inverter based Generation Systems 2016.08		Report No:	CN23Y4BO 001
Order No. :	244466490	Product:	Grid-Connected PV Inverter
Client Name :	SolaX Power Network Technology (Zhejiang) Co., Ltd.	Model designation:	X1-MINI-1.5K-G4

9. Over/Under voltage

PROCEDURE

Test methods complies with standard Protection and Control requirements for PEA Interface of Inverter based Generation Systems 2016.06.

RESULTS Pass / Fail

9	TABLE: Over/Under voltage		
	Mains voltage: 220V		
Setting value			
Voltage detection accuracy [V]	± 1V	Voltage detection cycle Td[ms]	20
Magnitude Vo1 [V]	243	delay time To1 [ms]	160
Magnitude Vo2 [V]	264	delay time To2 [ms]	160
Magnitude Vu1 [V]	197	delay time Tu1 [ms]	2000
Magnitude Vu2 [V]	109	delay time Tu2 [ms]	240
Over voltage level 1	Measurement [ms]	Limit [ms]	Remark
1	127.5	1000	Mains voltage from 218.7 V jump to 267.3 V
2	124.8		
Over voltage level 2	Measurement [ms]	Limit [ms]	Remark
1	28.7	160	Mains voltage from 237.6V jump to 290.4V
2	27.6		

Used equipment No.: See equipment list for details Sample No.: N/A
 Finished date: _____ Tested by: _____
 Review date: _____ Reviewed by: _____



Compliance Evaluation Report



REPORT No.: CSSC/BOS/005

ISSUED DATE: March 9, 2023

APPENDIX C. TÜV Rheinland's Report No: CN23Y4BO 001. (Cont.)

Test Data / Test Plan		 TÜVRheinland®	
TÜV Rheinland (Shanghai) Co., Ltd.		Document No.: TD-0189	
Protection and Control requirements for PEA Interface of Inverter based Generation Systems 2016.08		Report No:	CN23Y4BO 001
Order No. :	244466490	Product:	Grid-Connected PV Inverter
Client Name :	SolaX Power Network Technology (Zhejiang) Co., Ltd.	Model designation:	X1-MINI-1.5K-G4

Under voltage level 1	Measurement [ms]	Limit [ms]	Remark
1	1964.4	2000	Mains voltage from 216.7V jump to 177.3 V
2	1963.5		
Under voltage level 2	Measurement [ms]	Limit [ms]	Remark
1	269.8	300	Mains voltage from 119.9V jump to 98.1V
2	266.9		

Remark:
 Vo1= First level over voltage magnitude, Vo2= Second level over voltage magnitude,
 Vu1= First level under voltage magnitude, Vu2= Second level under voltage magnitude
 To1= Delayed time for first level over voltage tripping, To2= Delayed time for second level over voltage tripping
 Tu1= Delayed time for first level under voltage tripping, Tu2= Delayed time for second level under voltage tripping

Used equipment No.: See equipment list for details Sample No.: N/A
 Finished date: _____ Tested by: _____
 Review date: _____ Reviewed by: _____



Compliance Evaluation Report



REPORT No.: CSSC/BOS/005

ISSUED DATE: March 9, 2023

APPENDIX C. TÜV Rheinland's Report No: CN23Y4BO 001. (Cont.)

Test Data / Test Plan		TÜVRheinland®	
TÜV Rheinland (Shanghai) Co., Ltd.		Document No.: TD-0189	
Protection and Control requirements for PEA Interface of Inverter based Generation Systems 2016.08		Report No:	CN23Y4BO 001
Order No. :	244466490	Product:	Grid-Connected PV Inverter
Client Name :	SolaX Power Network Technology (Zhejiang) Co., Ltd.	Model designation:	X1-MINI-1.5K-G4

10. Harmonic and waveform distortion

PROCEDURE

Test methods complies with standard IEC 61000-3-12.

Limit see following table:

Table 2. Current distortion limits

Odd Harmonic	THD _i in each harmonic order (%)
3 - 9	4.0
11 - 15	2.0
17 - 21	1.5
23 - 33	0.6
Even Harmonic	THD _i in each harmonic order (%)
2 - 8	1.0
10 - 32	0.5

RESULTS Pass / Fail

10	TABLE: Harmonic and waveform distortion						
	Mains voltage: 220V						
P/P _n [%]	100%		66%		33%		Limit
Ordinal number	Measurement						
	[A]	[%]	[A]	[%]	[A]	[%]	[%]
1	6.98	100	4.54	100	2.29	100	—
2	0.02	0.29	0.02	0.29	0.02	0.29	1.0
3	0.08	1.15	0.04	0.57	0.02	0.29	4.0
4	0.01	0.14	0.01	0.14	0.01	0.14	1.0
5	0.08	1.15	0.06	0.86	0.05	0.72	4.0
6	0.00	0.00	0.01	0.14	0.01	0.14	1.0

Used equipment No.: See equipment list for details Sample No.: N/A
 Finished date: _____ Tested by: _____
 Review date: _____ Reviewed by: _____



Compliance Evaluation Report



REPORT No.: CSSC/BOS/005

ISSUED DATE: March 9, 2023

APPENDIX C. TÜV Rheinland's Report No: CN23Y4BO 001. (Cont.)

Test Data / Test Plan			
TÜV Rheinland (Shanghai) Co., Ltd.		Document No.: TD-0189	
Protection and Control requirements for PEA Interface of Inverter based Generation Systems 2016.08		Report No:	CN23Y4BO 001
Order No. :	244466490	Product:	Grid-Connected PV Inverter
Client Name :	SolaX Power Network Technology (Zhejiang) Co., Ltd.	Model designation:	X1-MINI-1.5K-G4

7	0.06	0.86	0.04	0.57	0.03	0.43	4.0
8	0.00	0.00	0.00	0.00	0.00	0.00	1.0
9	0.02	0.29	0.02	0.29	0.01	0.14	4.0
10	0.00	0.00	0.00	0.00	0.00	0.00	0.5
11	0.01	0.14	0.01	0.14	0.01	0.14	2.0
12	0.00	0.00	0.00	0.00	0.00	0.00	0.5
13	0.01	0.14	0.01	0.14	0.01	0.14	2.0
14	0.00	0.00	0.00	0.00	0.00	0.00	0.5
15	0.01	0.14	0.01	0.14	0.00	0.00	2.0
16	0.00	0.00	0.00	0.00	0.00	0.00	0.5
17	0.01	0.14	0.01	0.14	0.00	0.00	1.5
18	0.00	0.00	0.00	0.00	0.00	0.00	0.5
19	0.00	0.00	0.00	0.00	0.00	0.00	1.5
20	0.00	0.00	0.00	0.00	0.00	0.00	0.5
21	0.00	0.00	0.00	0.00	0.00	0.00	1.5
22	0.00	0.00	0.00	0.00	0.00	0.00	0.5
23	0.00	0.00	0.00	0.00	0.00	0.00	0.6
24	0.00	0.00	0.00	0.00	0.00	0.00	0.5
25	0.00	0.00	0.00	0.00	0.00	0.00	0.6
26	0.00	0.00	0.00	0.00	0.00	0.00	0.5
27	0.00	0.00	0.00	0.00	0.00	0.00	0.6
28	0.00	0.00	0.00	0.00	0.00	0.00	0.5
29	0.00	0.00	0.00	0.00	0.00	0.00	0.6
30	0.00	0.00	0.00	0.00	0.00	0.00	0.5

Used equipment No.: See equipment list for details Sample No.: N/A
 Finished date: _____ Tested by: _____
 Review date: _____ Reviewed by: _____



Compliance Evaluation Report



REPORT No.: CSSC/BOS/005

ISSUED DATE: March 9, 2023

APPENDIX C. TÜV Rheinland's Report No: CN23Y4BO 001. (Cont.)

Test Data / Test Plan		TÜVRheinland®	
TÜV Rheinland (Shanghai) Co., Ltd.		Document No.: TD-0189	
Protection and Control requirements for PEA Interface of Inverter based Generation Systems 2016.08		Report No:	CN23Y4BO 001
Order No. :	244466490	Product:	Grid-Connected PV Inverter
Client Name :	SolaX Power Network Technology (Zhejiang) Co., Ltd.	Model designation:	X1-MINI-1.5K-G4

31	0.00	0.00	0.00	0.00	0.00	0.00	0.6
32	0.00	0.00	0.00	0.00	0.00	0.00	0.5
33	0.00	0.00	0.00	0.00	0.00	0.00	0.6
THD	1.91		1.30		0.98		5
P/Pn[%]	100%		66%		33%		Limit
Ordinal number	Measurement						[%]
	[V]	[%]	[V]	[%]	[V]	[%]	
1	220.15	100	220.07	100	220.01	100	–
2	0.01	0.00	0.01	0.00	0.01	0.00	2
3	0.02	0.01	0.03	0.01	0.03	0.01	4
4	0.00	0.00	0.00	0.00	0.00	0.00	2
5	0.04	0.02	0.04	0.02	0.04	0.02	4
6	0.01	0.00	0.01	0.00	0.01	0.00	2
7	0.07	0.03	0.07	0.03	0.08	0.04	4
8	0.00	0.00	0.00	0.00	0.01	0.00	2
9	0.00	0.00	0.01	0.00	0.01	0.00	4
10	0.01	0.00	0.01	0.00	0.01	0.00	2
11	0.03	0.01	0.04	0.02	0.04	0.02	4
12	0.01	0.00	0.01	0.00	0.01	0.00	2
13	0.00	0.00	0.01	0.00	0.01	0.00	4
14	0.01	0.00	0.01	0.00	0.01	0.00	2
15	0.03	0.01	0.03	0.01	0.03	0.01	4
16	0.01	0.00	0.01	0.00	0.01	0.00	2
17	0.00	0.00	0.01	0.00	0.01	0.00	4
18	0.01	0.00	0.01	0.00	0.01	0.00	2

Used equipment No.: See equipment list for details Sample No.: N/A
 Finished date: _____ Tested by: _____
 Review date: _____ Reviewed by: _____



Compliance Evaluation Report



REPORT No.: CSSC/BOS/005

ISSUED DATE: March 9, 2023

APPENDIX C. TÜV Rheinland's Report No: CN23Y4BO 001. (Cont.)

Test Data / Test Plan				TÜVRheinland®			
TÜV Rheinland (Shanghai) Co., Ltd.				Document No.: TD-0189			
Protection and Control requirements for PEA Interface of Inverter based Generation Systems 2016.08				Report No:	CN23Y4BO 001		
Order No. :	244466490			Product:	Grid-Connected PV Inverter		
Client Name :	SolaX Power Network Technology (Zhejiang) Co., Ltd.			Model designation:	X1-MINI-1.5K-G4		
19	0.01	0.00	0.01	0.00	0.01	0.00	4
20	0.01	0.00	0.01	0.00	0.01	0.00	2
21	0.01	0.00	0.00	0.00	0.00	0.00	4
22	0.01	0.00	0.01	0.00	0.01	0.00	2
23	0.02	0.01	0.02	0.01	0.02	0.01	4
24	0.01	0.00	0.01	0.00	0.01	0.00	2
25	0.00	0.00	0.01	0.00	0.01	0.00	4
26	0.01	0.00	0.00	0.00	0.00	0.00	2
27	0.00	0.00	0.01	0.00	0.01	0.00	4
28	0.00	0.00	0.00	0.00	0.01	0.00	2
29	0.01	0.00	0.01	0.00	0.00	0.00	4
30	0.01	0.00	0.01	0.00	0.01	0.00	2
31	0.01	0.00	0.01	0.00	0.01	0.00	4
32	0.01	0.00	0.01	0.00	0.01	0.00	2
33	0.00	0.00	0.01	0.00	0.01	0.00	4
THD	0.05		0.05		0.05		5
Remark:							

Used equipment No.: See equipment list for details Sample No.: N/A
 Finished date: _____ Tested by: _____
 Review date: _____ Reviewed by: _____



Compliance Evaluation Report



REPORT No.: CSSC/BOS/005

ISSUED DATE: March 9, 2023

APPENDIX C. TÜV Rheinland's Report No: CN23Y4BO 001. (Cont.)

Test Data / Test Plan		TÜVRheinland®	
TÜV Rheinland (Shanghai) Co., Ltd.		Document No.: TD-0189	
Protection and Control requirements for PEA Interface of Inverter based Generation Systems 2016.08		Report No:	CN23Y4BO 001
Order No. :	244466490	Product:	Grid-Connected PV Inverter
Client Name :	SolaX Power Network Technology (Zhejiang) Co., Ltd.	Model designation:	X1-MINI-1.5K-G4

11. Over/Under Frequency

PROCEDURE

Test method complies with standard Protection and Control requirements for PEA Interface of Inverter based Generation Systems 2016.08.

RESULTS Pass / Fail

11	TABLE: Over/Under frequency		
	Rated voltage frequency: 50Hz		
Setting value			
Frequency detection accuracy [Hz]	± 0.1	Frequency detection cycle Td [ms]	20
Magnitude Fo [Hz]	52.1	Fo delay time To [ms]	100
Magnitude Fu [Hz]	46.9	Fu delay time Tu [ms]	100
Over frequency	Measurement [ms]	Limit [ms]	Remark
1	62.7	100	Mains voltage frequency From: 51.6Hz Jump to: 52.6Hz
Under frequency	Measurement [ms]	Limit [ms]	Remark
1	60.7	100	Mains voltage frequency From: 47.4Hz Jump to: 46.4Hz
Remark: Fo= Over frequency magnitude, Fu= Under frequency magnitude, To= Delayed time for over frequency tripping Tu= Delayed time for under frequency tripping			

Used equipment No.: See equipment list for details Sample No.: N/A
 Finished date: _____ Tested by: _____
 Review date: _____ Reviewed by: _____



Compliance Evaluation Report



REPORT No.: CSSC/BOS/005

ISSUED DATE: March 9, 2023

APPENDIX C. TÜV Rheinland's Report No: CN23Y4BO 001. (Cont.)

Test Data / Test Plan			
TÜV Rheinland (Shanghai) Co., Ltd.		Document No.: TD-0189	
Protection and Control requirements for PEA Interface of Inverter based Generation Systems 2016.08		Report No:	CN23Y4BO 001
Order No. :	244466490	Product:	Grid-Connected PV Inverter
Client Name :	SolaX Power Network Technology (Zhejiang) Co., Ltd.	Model designation:	X1-MINI-1.5K-G4

12. Active power control

PROCEDURE

The test methods complies with standard Protection and Control requirements for PEA Interface of Inverter based Generation Systems 2016.08.

RESULTS Pass / Fail

12	TABLE: Active power control											P
Rating power P (W)	1500											
Set Point	100%	90%	80%	70%	60%	50%	40%	30%	20%	10%	0%	
Output Power P (W)	1521	1359	1220	1080	942	768	628	453	311	151	65	
	Limitation of ΔP			$\pm 5\% P_n$								
Adjusting time (s)	-	0.2	0.2	0.6	0.6	0.6	0.2	0.2	0.2	0.2	0.6	
	Limitation of Δt			60								
Total Duration (s)	596											
Remark: ΔP - power deviation, Δt - response duration												

Used equipment No.: See equipment list for details Sample No.: N/A
 Finished date: _____ Tested by: _____
 Review date: _____ Reviewed by: _____



Compliance Evaluation Report



REPORT No.: CSSC/BOS/005

ISSUED DATE: March 9, 2023

APPENDIX C. TÜV Rheinland's Report No: CN23Y4BO 001. (Cont.)

Test Data / Test Plan		TÜVRheinland®	
TÜV Rheinland (Shanghai) Co., Ltd.		Document No.: TD-0189	
Protection and Control requirements for PEA Interface of Inverter based Generation Systems 2016.08		Report No:	CN23Y4BO 001
Order No. :	244466490	Product:	Grid-Connected PV Inverter
Client Name :	SolaX Power Network Technology (Zhejiang) Co., Ltd.	Model designation:	X1-MINI-1.5K-G4

Attachment : 1

Picture No.:	1	Clause:	7
Test:	<input checked="" type="checkbox"/> Islanding Protection <input type="checkbox"/> Secondary Over Voltage Magnitude <input type="checkbox"/> Secondary Over Voltage Trip Time <input type="checkbox"/> Secondary Under Voltage Magnitude <input type="checkbox"/> Secondary Under Voltage Trip Time <input type="checkbox"/> Under Frequency Magnitude <input type="checkbox"/> Under Frequency Trip Time		<input type="checkbox"/> First Over Voltage Magnitude <input type="checkbox"/> First Over Voltage Trip Time <input type="checkbox"/> First Under Voltage Magnitude <input type="checkbox"/> First Under Voltage Trip Time <input type="checkbox"/> Over Frequency Magnitude <input type="checkbox"/> Over Frequency Trip Time <input type="checkbox"/> Response to Utility Recovery
Test description:	100% load, PR: -10%, QC: +10%, Trip time 292ms. Wave No. 1 was the output current of inverter; Wave No. 2 was the current through the grid, also regarded as trip signal while the grid was switched off.		

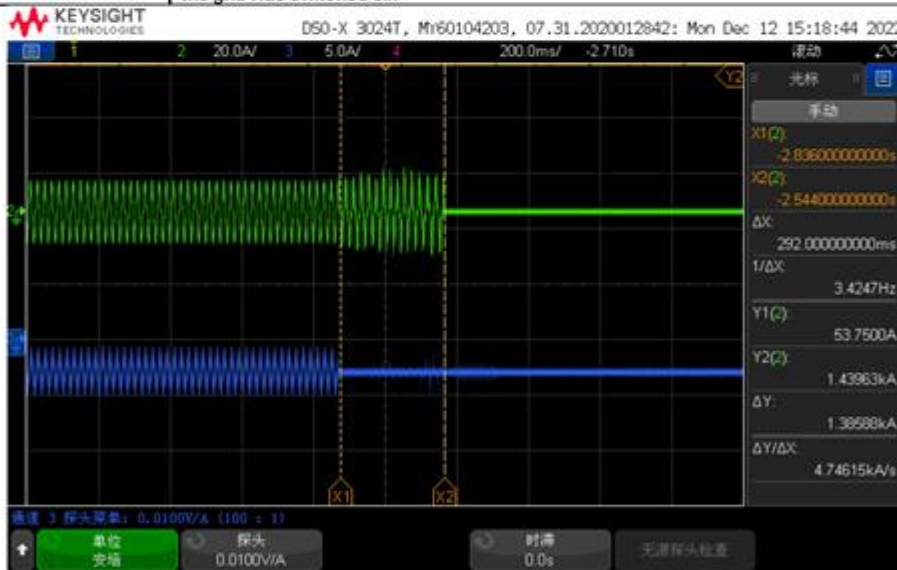

Used equipment No.: See equipment list for details Sample No.: N/A

Finished date: _____ Tested by: _____

Review date: _____ Reviewed by: _____



Compliance Evaluation Report



REPORT No.: CSSC/BOS/005

ISSUED DATE: March 9, 2023

APPENDIX C. TÜV Rheinland's Report No: CN23Y4BO 001. (Cont.)

Test Data / Test Plan		TÜVRheinland®	
TÜV Rheinland (Shanghai) Co., Ltd.		Document No.: TD-0189	
Protection and Control requirements for PEA Interface of Inverter based Generation Systems 2016.08		Report No:	CN23Y4BO 001
Order No. :	244466490	Product:	Grid-Connected PV Inverter
Client Name :	SolaX Power Network Technology (Zhejiang) Co., Ltd.	Model designation:	X1-MINI-1.5K-G4

Attachment : 1

Picture No.:	2	Clause:	7
Test:	<input checked="" type="checkbox"/> Islanding Protection <input type="checkbox"/> Secondary Over Voltage Magnitude <input type="checkbox"/> Secondary Over Voltage Trip Time <input type="checkbox"/> Secondary Under Voltage Magnitude <input type="checkbox"/> Secondary Under Voltage Trip Time <input type="checkbox"/> Under Frequency Magnitude <input type="checkbox"/> Under Frequency Trip Time		<input type="checkbox"/> First Over Voltage Magnitude <input type="checkbox"/> First Over Voltage Trip Time <input type="checkbox"/> First Under Voltage Magnitude <input type="checkbox"/> First Under Voltage Trip Time <input type="checkbox"/> Over Frequency Magnitude <input type="checkbox"/> Over Frequency Trip Time <input type="checkbox"/> Response to Utility Recovery
Test description:	100% load, PR: -10%, QC: +5%, trip time 202ms. Wave No. 1 was the output current of inverter; Wave No. 2 was the current through the grid, also regarded as trip signal while the grid was switched off.		

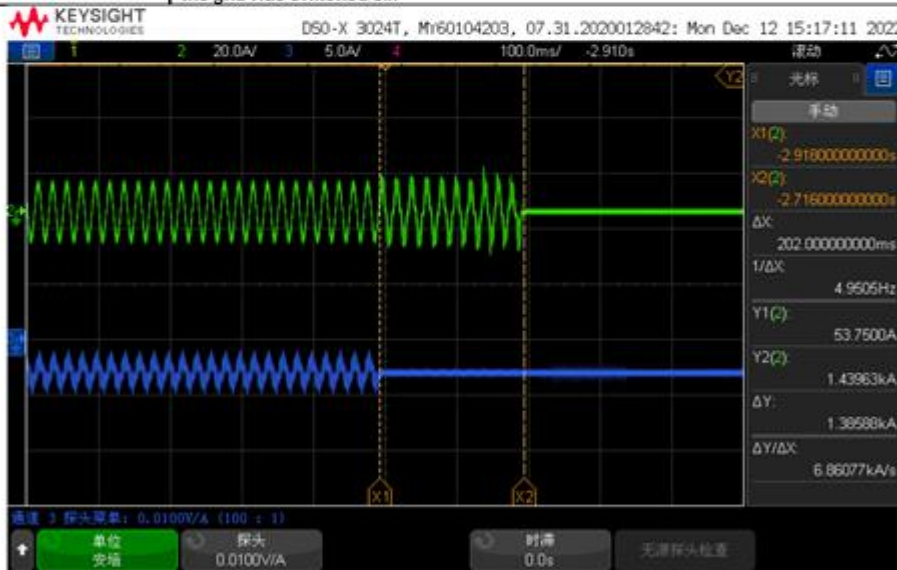

Used equipment No.: See equipment list for details Sample No.: N/A

Finished date: _____ Tested by: _____

Review date: _____ Reviewed by: _____



Compliance Evaluation Report



REPORT No.: CSSC/BOS/005

ISSUED DATE: March 9, 2023

APPENDIX C. TÜV Rheinland's Report No: CN23Y4BO 001. (Cont.)

Test Data / Test Plan		TÜVRheinland®	
TÜV Rheinland (Shanghai) Co., Ltd.		Document No.: TD-0189	
Protection and Control requirements for PEA Interface of Inverter based Generation Systems 2016.08		Report No:	CN23Y4BO 001
Order No. :	244466490	Product:	Grid-Connected PV Inverter
Client Name :	SolaX Power Network Technology (Zhejiang) Co., Ltd.	Model designation:	X1-MINI-1.5K-G4

Attachment : 1

Picture No.:	3	Clause:	7
Test:	<input checked="" type="checkbox"/> Islanding Protection <input type="checkbox"/> Secondary Over Voltage Magnitude <input type="checkbox"/> Secondary Over Voltage Trip Time <input type="checkbox"/> Secondary Under Voltage Magnitude <input type="checkbox"/> Secondary Under Voltage Trip Time <input type="checkbox"/> Under Frequency Magnitude <input type="checkbox"/> Under Frequency Trip Time		<input type="checkbox"/> First Over Voltage Magnitude <input type="checkbox"/> First Over Voltage Trip Time <input type="checkbox"/> First Under Voltage Magnitude <input type="checkbox"/> First Under Voltage Trip Time <input type="checkbox"/> Over Frequency Magnitude <input type="checkbox"/> Over Frequency Trip Time <input type="checkbox"/> Response to Utility Recovery
Test description:	100% load, PR: -10%, QC: 0%, trip time 228ms. Wave No. 1 was the output current of inverter; Wave No. 2 was the current through the grid, also regarded as trip signal while the grid was switched off.		

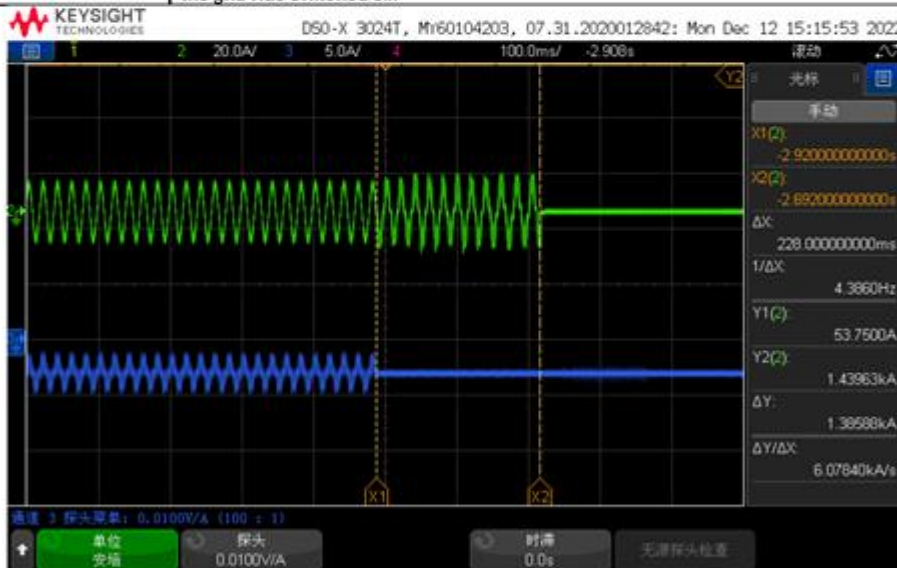

Used equipment No.: See equipment list for details Sample No.: N/A

Finished date: _____ Tested by: _____

Review date: _____ Reviewed by: _____



Compliance Evaluation Report



REPORT No.: CSSC/BOS/005

ISSUED DATE: March 9, 2023

APPENDIX C. TÜV Rheinland's Report No: CN23Y4BO 001. (Cont.)

Test Data / Test Plan		TÜVRheinland®	
TÜV Rheinland (Shanghai) Co., Ltd.		Document No.: TD-0189	
Protection and Control requirements for PEA Interface of Inverter based Generation Systems 2016.08		Report No:	CN23Y4BO 001
Order No. :	244466490	Product:	Grid-Connected PV Inverter
Client Name :	SolaX Power Network Technology (Zhejiang) Co., Ltd.	Model designation:	X1-MINI-1.5K-G4

Attachment : 1

Picture No.:	4	Clause:	7
Test:	<input checked="" type="checkbox"/> Islanding Protection <input type="checkbox"/> Secondary Over Voltage Magnitude <input type="checkbox"/> Secondary Over Voltage Trip Time <input type="checkbox"/> Secondary Under Voltage Magnitude <input type="checkbox"/> Secondary Under Voltage Trip Time <input type="checkbox"/> Under Frequency Magnitude <input type="checkbox"/> Under Frequency Trip Time		<input type="checkbox"/> First Over Voltage Magnitude <input type="checkbox"/> First Over Voltage Trip Time <input type="checkbox"/> First Under Voltage Magnitude <input type="checkbox"/> First Under Voltage Trip Time <input type="checkbox"/> Over Frequency Magnitude <input type="checkbox"/> Over Frequency Trip Time <input type="checkbox"/> Response to Utility Recovery
Test description:	100% load, PR: -10%, QC: -5%, trip time 94ms. Wave No. 1 was the output current of inverter; Wave No. 2 was the current through the grid, also regarded as trip signal while the grid was switched off.		

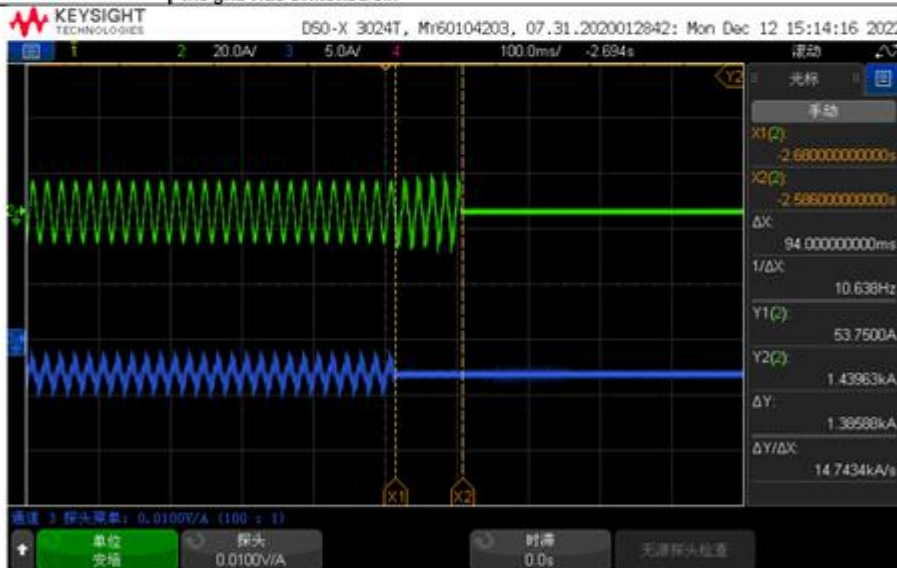

Used equipment No.: See equipment list for details Sample No.: N/A

Finished date: _____ Tested by: _____

Review date: _____ Reviewed by: _____



Compliance Evaluation Report



REPORT No.: CSSC/BOS/005

ISSUED DATE: March 9, 2023

APPENDIX C. TÜV Rheinland's Report No: CN23Y4BO 001. (Cont.)

Test Data / Test Plan		TÜVRheinland®	
TÜV Rheinland (Shanghai) Co., Ltd.		Document No.: TD-0189	
Protection and Control requirements for PEA Interface of Inverter based Generation Systems 2016.08		Report No:	CN23Y4BO 001
Order No. :	244466490	Product:	Grid-Connected PV Inverter
Client Name :	SolaX Power Network Technology (Zhejiang) Co., Ltd.	Model designation:	X1-MINI-1.5K-G4

Attachment : 1

Picture No.:	5	Clause:	7
Test:	<input checked="" type="checkbox"/> Islanding Protection <input type="checkbox"/> Secondary Over Voltage Magnitude <input type="checkbox"/> Secondary Over Voltage Trip Time <input type="checkbox"/> Secondary Under Voltage Magnitude <input type="checkbox"/> Secondary Under Voltage Trip Time <input type="checkbox"/> Under Frequency Magnitude <input type="checkbox"/> Under Frequency Trip Time		<input type="checkbox"/> First Over Voltage Magnitude <input type="checkbox"/> First Over Voltage Trip Time <input type="checkbox"/> First Under Voltage Magnitude <input type="checkbox"/> First Under Voltage Trip Time <input type="checkbox"/> Over Frequency Magnitude <input type="checkbox"/> Over Frequency Trip Time <input type="checkbox"/> Response to Utility Recovery
Test description:	100% load, PR: -10%, QC: -10%, trip time 76ms. Wave No. 1 was the output current of inverter; Wave No. 2 was the current through the grid, also regarded as trip signal while the grid was switched off.		

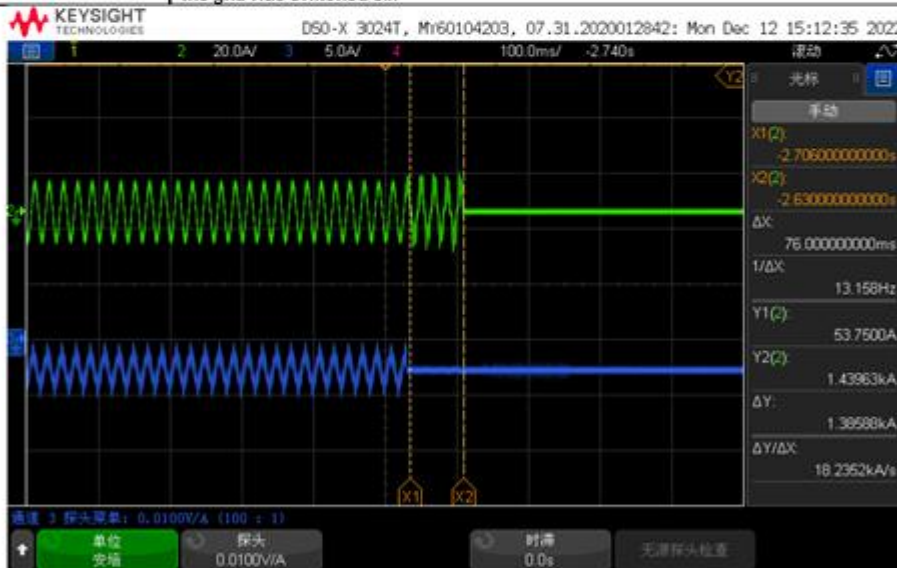

Used equipment No.: See equipment list for details Sample No.: N/A

Finished date: _____ Tested by: _____

Review date: _____ Reviewed by: _____



Compliance Evaluation Report



REPORT No.: CSSC/BOS/005

ISSUED DATE: March 9, 2023

APPENDIX C. TÜV Rheinland's Report No: CN23Y4BO 001. (Cont.)

Test Data / Test Plan		TÜVRheinland®	
TÜV Rheinland (Shanghai) Co., Ltd.		Document No.: TD-0189	
Protection and Control requirements for PEA Interface of Inverter based Generation Systems 2016.08		Report No:	CN23Y4BO 001
Order No. :	244466490	Product:	Grid-Connected PV Inverter
Client Name :	SolaX Power Network Technology (Zhejiang) Co., Ltd.	Model designation:	X1-MINI-1.5K-G4

Attachment : 1

Picture No.:	6	Clause:	7
Test:	<input checked="" type="checkbox"/> Islanding Protection <input type="checkbox"/> Secondary Over Voltage Magnitude <input type="checkbox"/> Secondary Over Voltage Trip Time <input type="checkbox"/> Secondary Under Voltage Magnitude <input type="checkbox"/> Secondary Under Voltage Trip Time <input type="checkbox"/> Under Frequency Magnitude <input type="checkbox"/> Under Frequency Trip Time		<input type="checkbox"/> First Over Voltage Magnitude <input type="checkbox"/> First Over Voltage Trip Time <input type="checkbox"/> First Under Voltage Magnitude <input type="checkbox"/> First Under Voltage Trip Time <input type="checkbox"/> Over Frequency Magnitude <input type="checkbox"/> Over Frequency Trip Time <input type="checkbox"/> Response to Utility Recovery
Test description:	100% load, PR: -5%, QC: +10%, trip time 100ms. Wave No. 1 was the output current of inverter; Wave No. 2 was the current through the grid, also regarded as trip signal while the grid was switched off.		



Used equipment No.: See equipment list for details Sample No.: N/A

Finished date: _____ Tested by: _____

Review date: _____ Reviewed by: _____



Compliance Evaluation Report



REPORT No.: CSSC/BOS/005

ISSUED DATE: March 9, 2023

APPENDIX C. TÜV Rheinland's Report No: CN23Y4BO 001. (Cont.)

Test Data / Test Plan		TÜVRheinland®	
TÜV Rheinland (Shanghai) Co., Ltd.		Document No.: TD-0189	
Protection and Control requirements for PEA Interface of Inverter based Generation Systems 2016.08		Report No:	CN23Y4BO 001
Order No. :	244466490	Product:	Grid-Connected PV Inverter
Client Name :	SolaX Power Network Technology (Zhejiang) Co., Ltd.	Model designation:	X1-MINI-1.5K-G4

Attachment : 1

Picture No.:	7	Clause:	7
Test:	<input checked="" type="checkbox"/> Islanding Protection <input type="checkbox"/> Secondary Over Voltage Magnitude <input type="checkbox"/> Secondary Over Voltage Trip Time <input type="checkbox"/> Secondary Under Voltage Magnitude <input type="checkbox"/> Secondary Under Voltage Trip Time <input type="checkbox"/> Under Frequency Magnitude <input type="checkbox"/> Under Frequency Trip Time		<input type="checkbox"/> First Over Voltage Magnitude <input type="checkbox"/> First Over Voltage Trip Time <input type="checkbox"/> First Under Voltage Magnitude <input type="checkbox"/> First Under Voltage Trip Time <input type="checkbox"/> Over Frequency Magnitude <input type="checkbox"/> Over Frequency Trip Time <input type="checkbox"/> Response to Utility Recovery
Test description:	100% load, PR: -5%, QC: -10%, trip time 84ms. Wave No. 1 was the output current of inverter; Wave No. 2 was the current through the grid, also regarded as trip signal while the grid was switched off.		

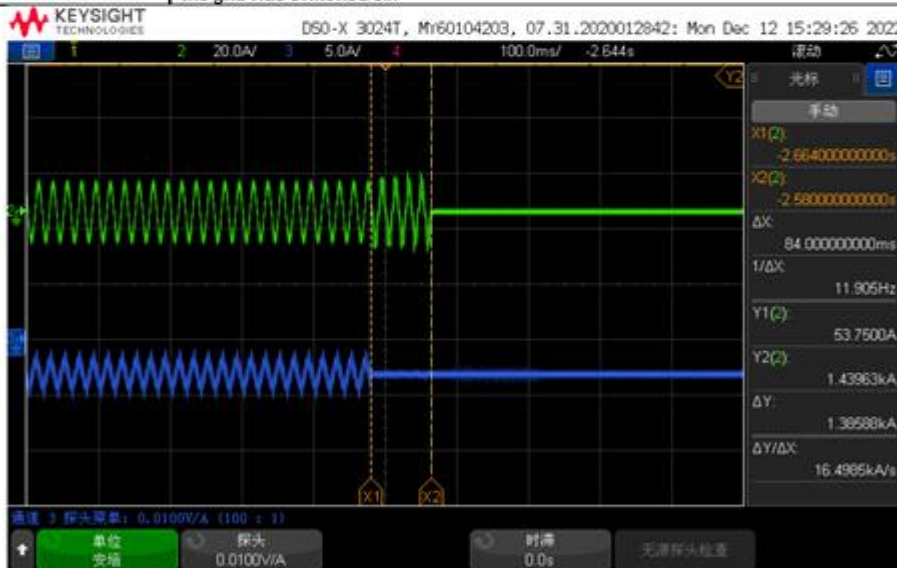

Used equipment No.: See equipment list for details Sample No.: N/A

Finished date: _____ Tested by: _____

Review date: _____ Reviewed by: _____



Compliance Evaluation Report



REPORT No.: CSSC/BOS/005

ISSUED DATE: March 9, 2023

APPENDIX C. TÜV Rheinland's Report No: CN23Y4BO 001. (Cont.)

Test Data / Test Plan		TÜVRheinland®	
TÜV Rheinland (Shanghai) Co., Ltd.		Document No.: TD-0189	
Protection and Control requirements for PEA Interface of Inverter based Generation Systems 2016.08		Report No:	CN23Y4BO 001
Order No. :	244466490	Product:	Grid-Connected PV Inverter
Client Name :	SolaX Power Network Technology (Zhejiang) Co., Ltd.	Model designation:	X1-MINI-1.5K-G4

Attachment : 1

Picture No.:	8	Clause:	7
Test:	<input checked="" type="checkbox"/> Islanding Protection <input type="checkbox"/> Secondary Over Voltage Magnitude <input type="checkbox"/> Secondary Over Voltage Trip Time <input type="checkbox"/> Secondary Under Voltage Magnitude <input type="checkbox"/> Secondary Under Voltage Trip Time <input type="checkbox"/> Under Frequency Magnitude <input type="checkbox"/> Under Frequency Trip Time		<input type="checkbox"/> First Over Voltage Magnitude <input type="checkbox"/> First Over Voltage Trip Time <input type="checkbox"/> First Under Voltage Magnitude <input type="checkbox"/> First Under Voltage Trip Time <input type="checkbox"/> Over Frequency Magnitude <input type="checkbox"/> Over Frequency Trip Time <input type="checkbox"/> Response to Utility Recovery
Test description:	100% load, PR: 0%, Qc: +10%, trip time 114ms. Wave No. 1 was the output current of inverter; Wave No. 2 was the current through the grid, also regarded as trip signal while the grid was switched off.		



Used equipment No.: See equipment list for details Sample No.: N/A

Finished date: _____ Tested by: _____

Review date: _____ Reviewed by: _____



Compliance Evaluation Report



REPORT No.: CSSC/BOS/005

ISSUED DATE: March 9, 2023

APPENDIX C. TÜV Rheinland's Report No: CN23Y4BO 001. (Cont.)

Test Data / Test Plan		TÜVRheinland®	
TÜV Rheinland (Shanghai) Co., Ltd.		Document No.: TD-0189	
Protection and Control requirements for PEA Interface of Inverter based Generation Systems 2016.08		Report No:	CN23Y4BO 001
Order No. :	244466490	Product:	Grid-Connected PV Inverter
Client Name :	SolaX Power Network Technology (Zhejiang) Co., Ltd.	Model designation:	X1-MINI-1.5K-G4

Attachment : 1

Picture No.:	9	Clause:	7
Test:	<input checked="" type="checkbox"/> Islanding Protection <input type="checkbox"/> Secondary Over Voltage Magnitude <input type="checkbox"/> Secondary Over Voltage Trip Time <input type="checkbox"/> Secondary Under Voltage Magnitude <input type="checkbox"/> Secondary Under Voltage Trip Time <input type="checkbox"/> Under Frequency Magnitude <input type="checkbox"/> Under Frequency Trip Time		<input type="checkbox"/> First Over Voltage Magnitude <input type="checkbox"/> First Over Voltage Trip Time <input type="checkbox"/> First Under Voltage Magnitude <input type="checkbox"/> First Under Voltage Trip Time <input type="checkbox"/> Over Frequency Magnitude <input type="checkbox"/> Over Frequency Trip Time <input type="checkbox"/> Response to Utility Recovery
Test description:	100% load, PR: -5%, QC: +5%, trip time 124ms. Wave No. 1 was the output current of inverter; Wave No. 2 was the current through the grid, also regarded as trip signal while the grid was switched off.		

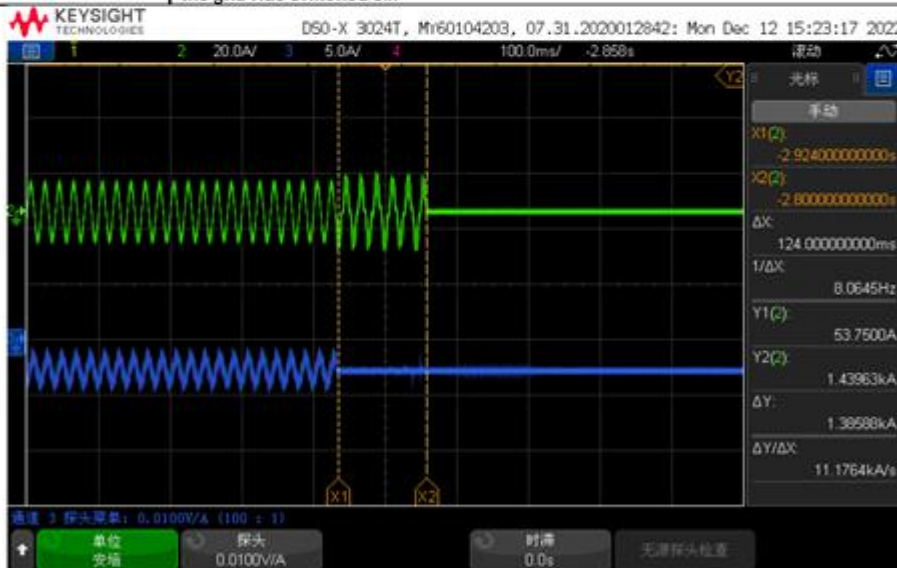

Used equipment No.: See equipment list for details Sample No.: N/A

Finished date: _____ Tested by: _____

Review date: _____ Reviewed by: _____



Compliance Evaluation Report



REPORT No.: CSSC/BOS/005

ISSUED DATE: March 9, 2023

APPENDIX C. TÜV Rheinland's Report No: CN23Y4BO 001. (Cont.)

Test Data / Test Plan			
TÜV Rheinland (Shanghai) Co., Ltd.		Document No.: TD-0189	
Protection and Control requirements for PEA Interface of Inverter based Generation Systems 2016.08		Report No:	CN23Y4BO 001
Order No. :	244466490	Product:	Grid-Connected PV Inverter
Client Name :	SolaX Power Network Technology (Zhejiang) Co., Ltd.	Model designation:	X1-MINI-1.5K-G4

Attachment : 1

Picture No.:	10	Clause:	7
Test:	<input checked="" type="checkbox"/> Islanding Protection <input type="checkbox"/> Secondary Over Voltage Magnitude <input type="checkbox"/> Secondary Over Voltage Trip Time <input type="checkbox"/> Secondary Under Voltage Magnitude <input type="checkbox"/> Secondary Under Voltage Trip Time <input type="checkbox"/> Under Frequency Magnitude <input type="checkbox"/> Under Frequency Trip Time <input type="checkbox"/> First Over Voltage Magnitude <input type="checkbox"/> First Over Voltage Trip Time <input type="checkbox"/> First Under Voltage Magnitude <input type="checkbox"/> First Under Voltage Trip Time <input type="checkbox"/> Over Frequency Magnitude <input type="checkbox"/> Over Frequency Trip Time <input type="checkbox"/> Response to Utility Recovery		
Test description:	100% load, PR: -5%, QC: 0%, trip time 370ms. Wave No. 1 was the output current of inverter; Wave No. 2 was the current through the grid, also regarded as trip signal while the grid was switched off.		

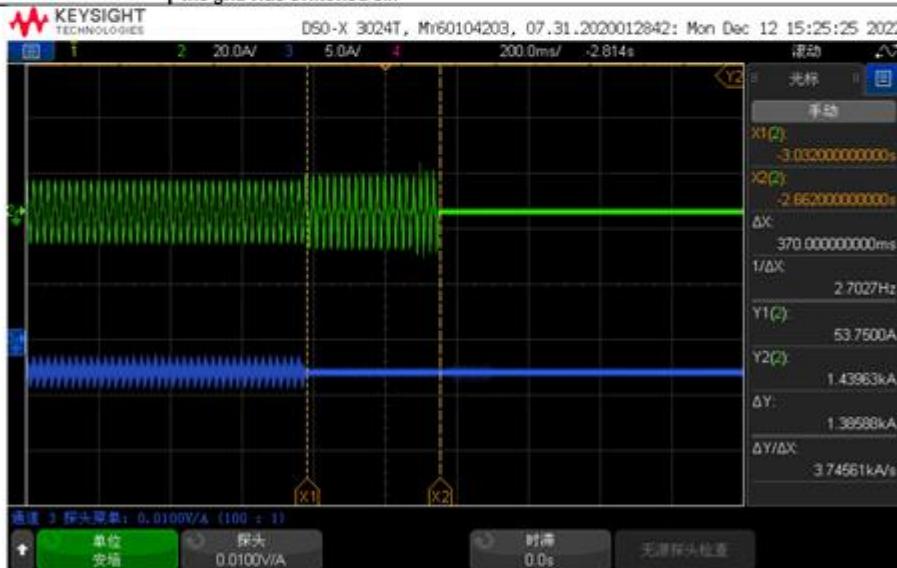

Used equipment No.: See equipment list for details Sample No.: N/A

Finished date: _____ Tested by: _____

Review date: _____ Reviewed by: _____



Compliance Evaluation Report



REPORT No.: CSSC/BOS/005

ISSUED DATE: March 9, 2023

APPENDIX C. TÜV Rheinland's Report No: CN23Y4BO 001. (Cont.)

Test Data / Test Plan			
TÜV Rheinland (Shanghai) Co., Ltd.		Document No.: TD-0189	
Protection and Control requirements for PEA Interface of Inverter based Generation Systems 2016.08		Report No:	CN23Y4BO 001
Order No. :	244466490	Product:	Grid-Connected PV Inverter
Client Name :	SolaX Power Network Technology (Zhejiang) Co., Ltd.	Model designation:	X1-MINI-1.5K-G4

Attachment : 1

Picture No.:	11	Clause:	7
Test:	<input checked="" type="checkbox"/> Islanding Protection <input type="checkbox"/> Secondary Over Voltage Magnitude <input type="checkbox"/> Secondary Over Voltage Trip Time <input type="checkbox"/> Secondary Under Voltage Magnitude <input type="checkbox"/> Secondary Under Voltage Trip Time <input type="checkbox"/> Under Frequency Magnitude <input type="checkbox"/> Under Frequency Trip Time <input type="checkbox"/> First Over Voltage Magnitude <input type="checkbox"/> First Over Voltage Trip Time <input type="checkbox"/> First Under Voltage Magnitude <input type="checkbox"/> First Under Voltage Trip Time <input type="checkbox"/> Over Frequency Magnitude <input type="checkbox"/> Over Frequency Trip Time <input type="checkbox"/> Response to Utility Recovery		
Test description:	100% load, PR: -5%, QC: -5%, trip time 110ms. Wave No. 1 was the output current of inverter; Wave No. 2 was the current through the grid, also regarded as trip signal while the grid was switched off.		

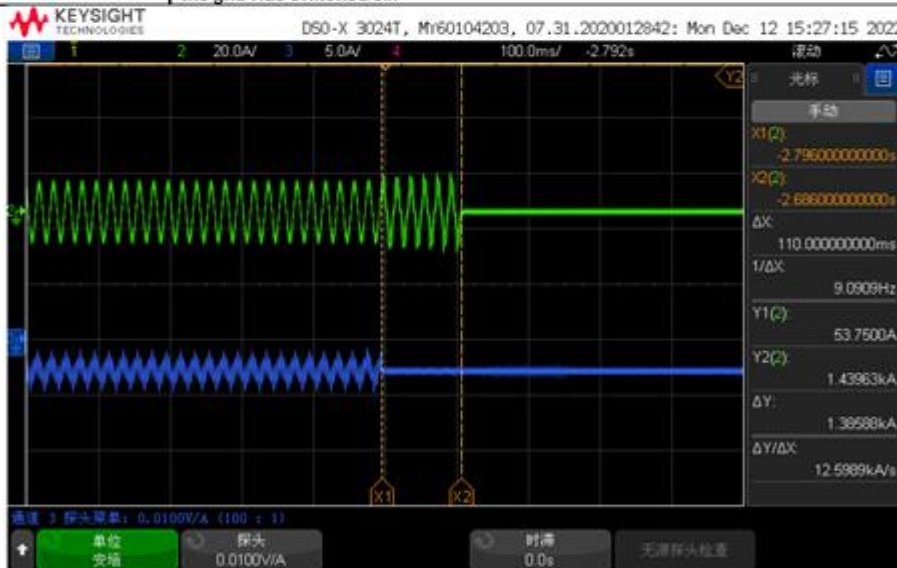

Used equipment No.: See equipment list for details Sample No.: N/A

Finished date: _____ Tested by: _____

Review date: _____ Reviewed by: _____



Compliance Evaluation Report



REPORT No.: CSSC/BOS/005

ISSUED DATE: March 9, 2023

APPENDIX C. TÜV Rheinland's Report No: CN23Y4BO 001. (Cont.)

Test Data / Test Plan			
TÜV Rheinland (Shanghai) Co., Ltd.		Document No.: TD-0189	
Protection and Control requirements for PEA Interface of Inverter based Generation Systems 2016.08		Report No:	CN23Y4BO 001
Order No. :	244466490	Product:	Grid-Connected PV Inverter
Client Name :	SolaX Power Network Technology (Zhejiang) Co., Ltd.	Model designation:	X1-MINI-1.5K-G4

Attachment : 1

Picture No.:	12	Clause:	7
Test:	<input checked="" type="checkbox"/> Islanding Protection <input type="checkbox"/> Secondary Over Voltage Magnitude <input type="checkbox"/> Secondary Over Voltage Trip Time <input type="checkbox"/> Secondary Under Voltage Magnitude <input type="checkbox"/> Secondary Under Voltage Trip Time <input type="checkbox"/> Under Frequency Magnitude <input type="checkbox"/> Under Frequency Trip Time <input type="checkbox"/> First Over Voltage Magnitude <input type="checkbox"/> First Over Voltage Trip Time <input type="checkbox"/> First Under Voltage Magnitude <input type="checkbox"/> First Under Voltage Trip Time <input type="checkbox"/> Over Frequency Magnitude <input type="checkbox"/> Over Frequency Trip Time <input type="checkbox"/> Response to Utility Recovery		
Test description:	100% load, PR: 0%, QC: +5%, trip time 186ms. Wave No. 1 was the output current of inverter; Wave No. 2 was the current through the grid, also regarded as trip signal while the grid was switched off.		

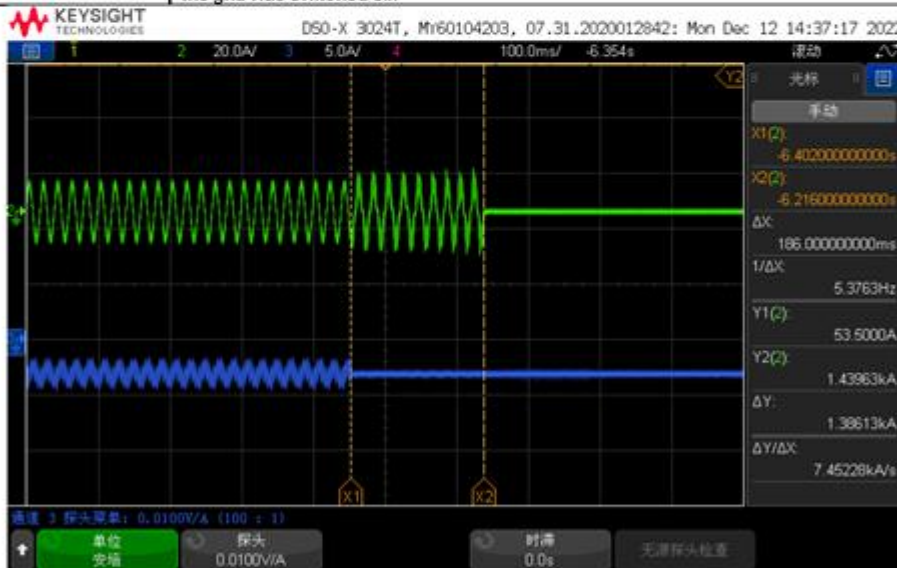

Used equipment No.: See equipment list for details Sample No.: N/A

Finished date: _____ Tested by: _____

Review date: _____ Reviewed by: _____



Compliance Evaluation Report



REPORT No.: CSSC/BOS/005

ISSUED DATE: March 9, 2023

APPENDIX C. TÜV Rheinland's Report No: CN23Y4BO 001. (Cont.)

Test Data / Test Plan		TÜVRheinland®	
TÜV Rheinland (Shanghai) Co., Ltd.		Document No.: TD-0189	
Protection and Control requirements for PEA Interface of Inverter based Generation Systems 2016.08		Report No:	CN23Y4BO 001
Order No. :	244466490	Product:	Grid-Connected PV Inverter
Client Name :	SolaX Power Network Technology (Zhejiang) Co., Ltd.	Model designation:	X1-MINI-1.5K-G4

Attachment : 1

Picture No.:	13	Clause:	7
Test:	<input checked="" type="checkbox"/> Islanding Protection <input type="checkbox"/> Secondary Over Voltage Magnitude <input type="checkbox"/> Secondary Over Voltage Trip Time <input type="checkbox"/> Secondary Under Voltage Magnitude <input type="checkbox"/> Secondary Under Voltage Trip Time <input type="checkbox"/> Under Frequency Magnitude <input type="checkbox"/> Under Frequency Trip Time		<input type="checkbox"/> First Over Voltage Magnitude <input type="checkbox"/> First Over Voltage Trip Time <input type="checkbox"/> First Under Voltage Magnitude <input type="checkbox"/> First Under Voltage Trip Time <input type="checkbox"/> Over Frequency Magnitude <input type="checkbox"/> Over Frequency Trip Time <input type="checkbox"/> Response to Utility Recovery
Test description:	100% load, PR: 0%, QC: 0%, trip time 302ms. Wave No. 1 was the output current of inverter; Wave No. 2 was the current through the grid, also regarded as trip signal while the grid was switched off.		

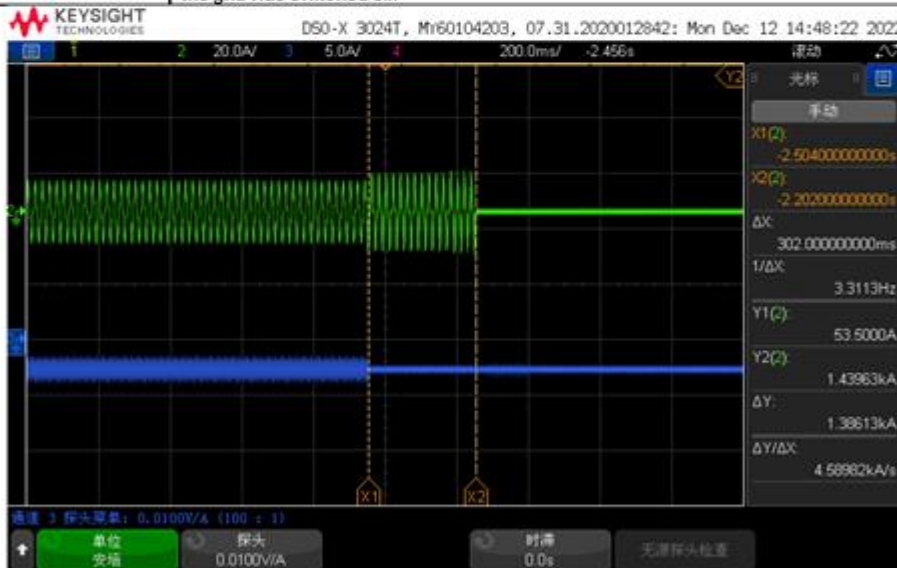

Used equipment No.: See equipment list for details Sample No.: N/A

Finished date: _____ Tested by: _____

Review date: _____ Reviewed by: _____



Compliance Evaluation Report



REPORT No.: CSSC/BOS/005

ISSUED DATE: March 9, 2023

APPENDIX C. TÜV Rheinland's Report No: CN23Y4BO 001. (Cont.)

Test Data / Test Plan		TÜVRheinland®	
TÜV Rheinland (Shanghai) Co., Ltd.		Document No.: TD-0189	
Protection and Control requirements for PEA Interface of Inverter based Generation Systems 2016.08		Report No:	CN23Y4BO 001
Order No. :	244466490	Product:	Grid-Connected PV Inverter
Client Name :	SolaX Power Network Technology (Zhejiang) Co., Ltd.	Model designation:	X1-MINI-1.5K-G4

Attachment : 1

Picture No.:	14	Clause:	7
Test:	<input checked="" type="checkbox"/> Islanding Protection <input type="checkbox"/> Secondary Over Voltage Magnitude <input type="checkbox"/> Secondary Over Voltage Trip Time <input type="checkbox"/> Secondary Under Voltage Magnitude <input type="checkbox"/> Secondary Under Voltage Trip Time <input type="checkbox"/> Under Frequency Magnitude <input type="checkbox"/> Under Frequency Trip Time		<input type="checkbox"/> First Over Voltage Magnitude <input type="checkbox"/> First Over Voltage Trip Time <input type="checkbox"/> First Under Voltage Magnitude <input type="checkbox"/> First Under Voltage Trip Time <input type="checkbox"/> Over Frequency Magnitude <input type="checkbox"/> Over Frequency Trip Time <input type="checkbox"/> Response to Utility Recovery
Test description:	At the balance condition of 100% load, the fundamental magnitude of grid current was 0.014A(1 st harmonic), less than 1% of the rating current 0.068A, See the screenshot of power analyzer for detail.		

X1-Mini-G4

	相1		三相总和	
U_tRMS	220.04	V	220.04	V
I_tRMS	153.71	mA	153.71	mA
P_t	-704.83	mW	-704.83	mW
Q_t	33.543	var	33.543	var
S_t	33.822	VA	33.822	VA
PF_t	-0.0299		-0.0299	
F_fund			50.000	Hz
U_fundRMS	220.04	V	220.04	V
I_fundRMS	14.705	mA	14.705	mA
P_fund	-720.97	mW	-720.97	mW
Q_fund	-754.87	mvar	-754.87	mvar
S_fund	3.2356	VA	3.2356	VA

Used equipment No.: See equipment list for details Sample No.: N/A
 Finished date: _____ Tested by: _____
 Review date: _____ Reviewed by: _____



Compliance Evaluation Report



REPORT No.: CSSC/BOS/005

ISSUED DATE: March 9, 2023

APPENDIX C. TÜV Rheinland's Report No: CN23Y4BO 001. (Cont.)

Test Data / Test Plan		TÜVRheinland®	
TÜV Rheinland (Shanghai) Co., Ltd.		Document No.: TD-0189	
Protection and Control requirements for PEA Interface of Inverter based Generation Systems 2016.08		Report No:	CN23Y4BO 001
Order No. :	244466490	Product:	Grid-Connected PV Inverter
Client Name :	SolaX Power Network Technology (Zhejiang) Co., Ltd.	Model designation:	X1-MINI-1.5K-G4

Attachment : 1

Picture No.:	15	Clause:	7
Test:	<input checked="" type="checkbox"/> Islanding Protection <input type="checkbox"/> Secondary Over Voltage Magnitude <input type="checkbox"/> Secondary Over Voltage Trip Time <input type="checkbox"/> Secondary Under Voltage Magnitude <input type="checkbox"/> Secondary Under Voltage Trip Time <input type="checkbox"/> Under Frequency Magnitude <input type="checkbox"/> Under Frequency Trip Time		<input type="checkbox"/> First Over Voltage Magnitude <input type="checkbox"/> First Over Voltage Trip Time <input type="checkbox"/> First Under Voltage Magnitude <input type="checkbox"/> First Under Voltage Trip Time <input type="checkbox"/> Over Frequency Magnitude <input type="checkbox"/> Over Frequency Trip Time <input type="checkbox"/> Response to Utility Recovery
Test description:	100% load, PR: 0%, CC: -5%, trip time 98ms. Wave No. 1 was the output current of inverter; Wave No. 2 was the current through the grid, also regarded as trip signal while the grid was switched off.		

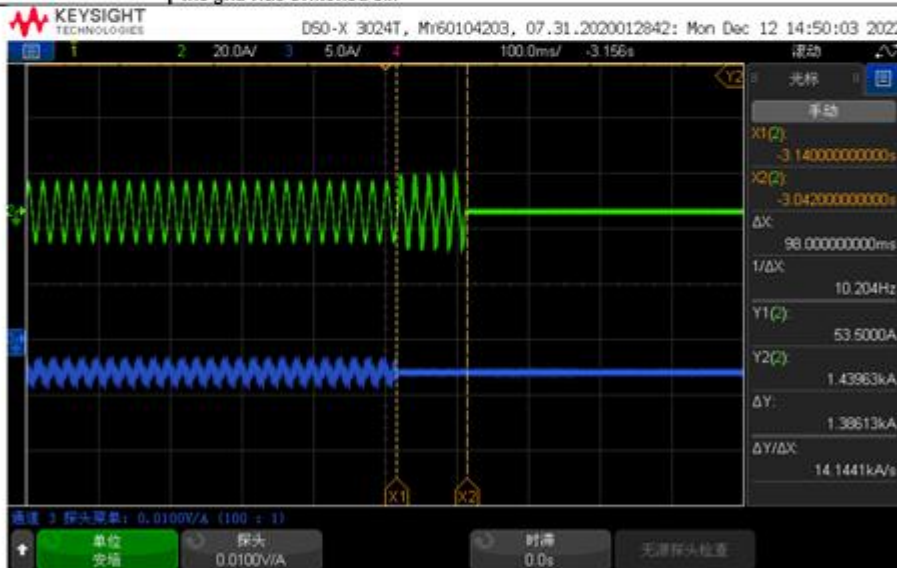

Used equipment No.: See equipment list for details Sample No.: N/A

Finished date: _____ Tested by: _____

Review date: _____ Reviewed by: _____



Compliance Evaluation Report



REPORT No.: CSSC/BOS/005

ISSUED DATE: March 9, 2023

APPENDIX C. TÜV Rheinland's Report No: CN23Y4BO 001. (Cont.)

Test Data / Test Plan			
TÜV Rheinland (Shanghai) Co., Ltd.		Document No.: TD-0189	
Protection and Control requirements for PEA Interface of Inverter based Generation Systems 2016.08		Report No:	CN23Y4BO 001
Order No. :	244466490	Product:	Grid-Connected PV Inverter
Client Name :	SolaX Power Network Technology (Zhejiang) Co., Ltd.	Model designation:	X1-MINI-1.5K-G4

Attachment : 1

Picture No.:	16	Clause:	7
Test:	<input checked="" type="checkbox"/> Islanding Protection <input type="checkbox"/> Secondary Over Voltage Magnitude <input type="checkbox"/> Secondary Over Voltage Trip Time <input type="checkbox"/> Secondary Under Voltage Magnitude <input type="checkbox"/> Secondary Under Voltage Trip Time <input type="checkbox"/> Under Frequency Magnitude <input type="checkbox"/> Under Frequency Trip Time <input type="checkbox"/> First Over Voltage Magnitude <input type="checkbox"/> First Over Voltage Trip Time <input type="checkbox"/> First Under Voltage Magnitude <input type="checkbox"/> First Under Voltage Trip Time <input type="checkbox"/> Over Frequency Magnitude <input type="checkbox"/> Over Frequency Trip Time <input type="checkbox"/> Response to Utility Recovery		
Test description:	100% load, PR: +5%, CC: +5%, trip time 138ms. Wave No. 1 was the output current of inverter; Wave No. 2 was the current through the grid, also regarded as trip signal while the grid was switched off.		

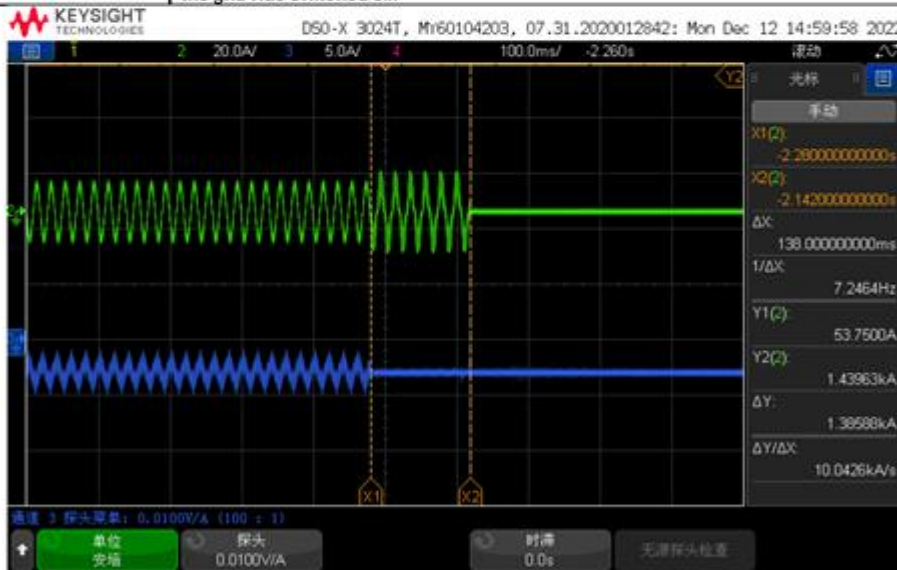

Used equipment No.: See equipment list for details Sample No.: N/A

Finished date: _____ Tested by: _____

Review date: _____ Reviewed by: _____



Compliance Evaluation Report



REPORT No.: CSSC/BOS/005

ISSUED DATE: March 9, 2023

APPENDIX C. TÜV Rheinland's Report No: CN23Y4BO 001. (Cont.)

Test Data / Test Plan		TÜVRheinland®	
TÜV Rheinland (Shanghai) Co., Ltd.		Document No.: TD-0189	
Protection and Control requirements for PEA Interface of Inverter based Generation Systems 2016.08		Report No:	CN23Y4BO 001
Order No. :	244466490	Product:	Grid-Connected PV Inverter
Client Name :	SolaX Power Network Technology (Zhejiang) Co., Ltd.	Model designation:	X1-MINI-1.5K-G4

Attachment : 1

Picture No.:	17	Clause:	7
Test:	<input checked="" type="checkbox"/> Islanding Protection <input type="checkbox"/> Secondary Over Voltage Magnitude <input type="checkbox"/> Secondary Over Voltage Trip Time <input type="checkbox"/> Secondary Under Voltage Magnitude <input type="checkbox"/> Secondary Under Voltage Trip Time <input type="checkbox"/> Under Frequency Magnitude <input type="checkbox"/> Under Frequency Trip Time		<input type="checkbox"/> First Over Voltage Magnitude <input type="checkbox"/> First Over Voltage Trip Time <input type="checkbox"/> First Under Voltage Magnitude <input type="checkbox"/> First Under Voltage Trip Time <input type="checkbox"/> Over Frequency Magnitude <input type="checkbox"/> Over Frequency Trip Time <input type="checkbox"/> Response to Utility Recovery
Test description:	100% load, PR: +5%, CC: 0%, trip time 422.0ms. Wave No. 1 was the output current of inverter; Wave No. 2 was the current through the grid, also regarded as trip signal while the grid was switched off.		

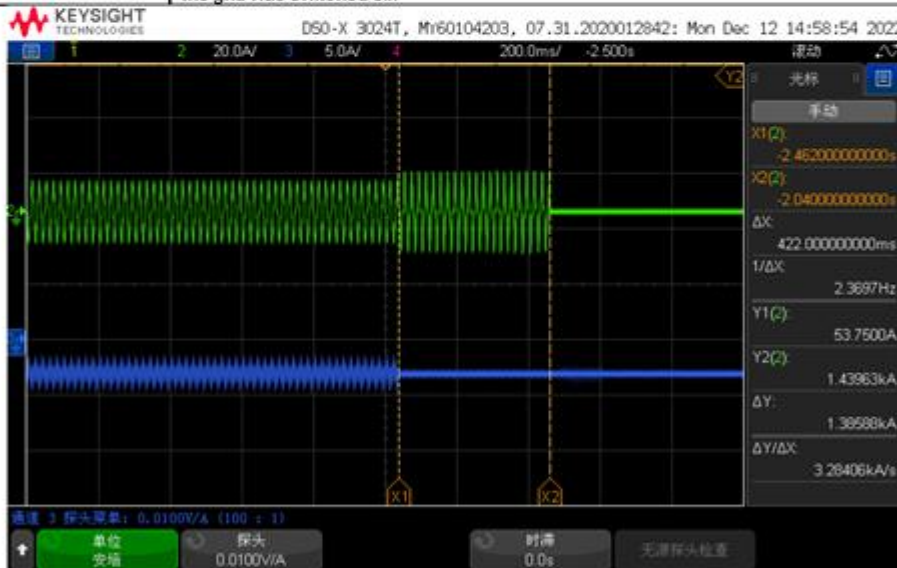

Used equipment No.: See equipment list for details Sample No.: N/A

Finished date: _____ Tested by: _____

Review date: _____ Reviewed by: _____



Compliance Evaluation Report



REPORT No.: CSSC/BOS/005

ISSUED DATE: March 9, 2023

APPENDIX C. TÜV Rheinland's Report No: CN23Y4BO 001. (Cont.)

Test Data / Test Plan			
TÜV Rheinland (Shanghai) Co., Ltd.		Document No.: TD-0189	
Protection and Control requirements for PEA Interface of Inverter based Generation Systems 2016.08		Report No:	CN23Y4BO 001
Order No. :	244466490	Product:	Grid-Connected PV Inverter
Client Name :	SolaX Power Network Technology (Zhejiang) Co., Ltd.	Model designation:	X1-MINI-1.5K-G4

Attachment : 1

Picture No.:	18	Clause:	7
Test:	<input checked="" type="checkbox"/> Islanding Protection <input type="checkbox"/> Secondary Over Voltage Magnitude <input type="checkbox"/> Secondary Over Voltage Trip Time <input type="checkbox"/> Secondary Under Voltage Magnitude <input type="checkbox"/> Secondary Under Voltage Trip Time <input type="checkbox"/> Under Frequency Magnitude <input type="checkbox"/> Under Frequency Trip Time <input type="checkbox"/> First Over Voltage Magnitude <input type="checkbox"/> First Over Voltage Trip Time <input type="checkbox"/> First Under Voltage Magnitude <input type="checkbox"/> First Under Voltage Trip Time <input type="checkbox"/> Over Frequency Magnitude <input type="checkbox"/> Over Frequency Trip Time <input type="checkbox"/> Response to Utility Recovery		
Test description:	100% load, PR: +5%, CC: -5%, trip time 114ms. Wave No. 1 was the output current of inverter; Wave No. 2 was the current through the grid, also regarded as trip signal while the grid was switched off.		

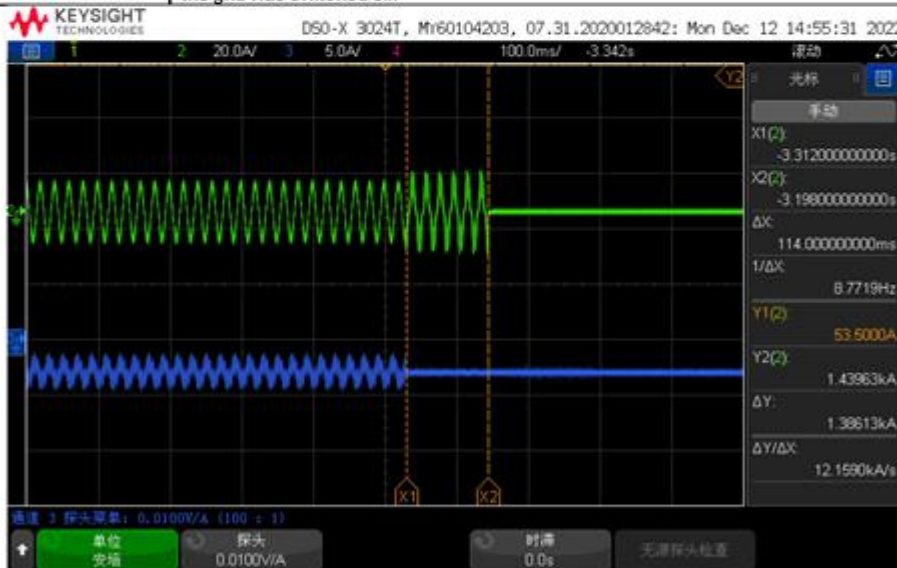

Used equipment No.: See equipment list for details Sample No.: N/A

Finished date: _____ Tested by: _____

Review date: _____ Reviewed by: _____



Compliance Evaluation Report



REPORT No.: CSSC/BOS/005

ISSUED DATE: March 9, 2023

APPENDIX C. TÜV Rheinland's Report No: CN23Y4BO 001. (Cont.)

Test Data / Test Plan		TÜVRheinland®	
TÜV Rheinland (Shanghai) Co., Ltd.		Document No.: TD-0189	
Protection and Control requirements for PEA Interface of Inverter based Generation Systems 2016.08		Report No:	CN23Y4BO 001
Order No. :	244466490	Product:	Grid-Connected PV Inverter
Client Name :	SolaX Power Network Technology (Zhejiang) Co., Ltd.	Model designation:	X1-MINI-1.5K-G4

Attachment : 1

Picture No.:	19	Clause:	7
Test:	<input checked="" type="checkbox"/> Islanding Protection <input type="checkbox"/> Secondary Over Voltage Magnitude <input type="checkbox"/> Secondary Over Voltage Trip Time <input type="checkbox"/> Secondary Under Voltage Magnitude <input type="checkbox"/> Secondary Under Voltage Trip Time <input type="checkbox"/> Under Frequency Magnitude <input type="checkbox"/> Under Frequency Trip Time		<input type="checkbox"/> First Over Voltage Magnitude <input type="checkbox"/> First Over Voltage Trip Time <input type="checkbox"/> First Under Voltage Magnitude <input type="checkbox"/> First Under Voltage Trip Time <input type="checkbox"/> Over Frequency Magnitude <input type="checkbox"/> Over Frequency Trip Time <input type="checkbox"/> Response to Utility Recovery
Test description:	100% load, PR: 0%, CC: -10%, trip time 102ms Wave No. 1 was the output current of inverter; Wave No. 2 was the current through the grid, also regarded as trip signal while the grid was switched off.		

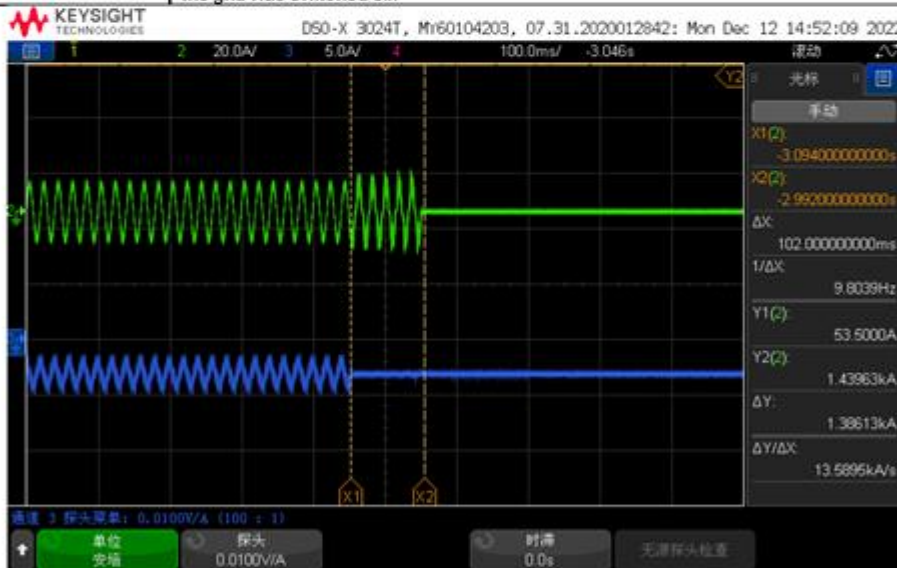

Used equipment No.: See equipment list for details Sample No.: N/A

Finished date: _____ Tested by: _____

Review date: _____ Reviewed by: _____



Compliance Evaluation Report



REPORT No.: CSSC/BOS/005

ISSUED DATE: March 9, 2023

APPENDIX C. TÜV Rheinland's Report No: CN23Y4BO 001. (Cont.)

Test Data / Test Plan		TÜVRheinland®	
TÜV Rheinland (Shanghai) Co., Ltd.		Document No.: TD-0189	
Protection and Control requirements for PEA Interface of Inverter based Generation Systems 2016.08		Report No:	CN23Y4BO 001
Order No. :	244466490	Product:	Grid-Connected PV Inverter
Client Name :	SolaX Power Network Technology (Zhejiang) Co., Ltd.	Model designation:	X1-MINI-1.5K-G4

Attachment : 1

Picture No.:	20	Clause:	7
Test:	<input checked="" type="checkbox"/> Islanding Protection <input type="checkbox"/> Secondary Over Voltage Magnitude <input type="checkbox"/> Secondary Over Voltage Trip Time <input type="checkbox"/> Secondary Under Voltage Magnitude <input type="checkbox"/> Secondary Under Voltage Trip Time <input type="checkbox"/> Under Frequency Magnitude <input type="checkbox"/> Under Frequency Trip Time		<input type="checkbox"/> First Over Voltage Magnitude <input type="checkbox"/> First Over Voltage Trip Time <input type="checkbox"/> First Under Voltage Magnitude <input type="checkbox"/> First Under Voltage Trip Time <input type="checkbox"/> Over Frequency Magnitude <input type="checkbox"/> Over Frequency Trip Time <input type="checkbox"/> Response to Utility Recovery
Test description:	100% load, PR: +5%, CC: +10%, trip time 118ms. Wave No. 1 was the output current of inverter; Wave No. 2 was the current through the grid, also regarded as trip signal while the grid was switched off.		

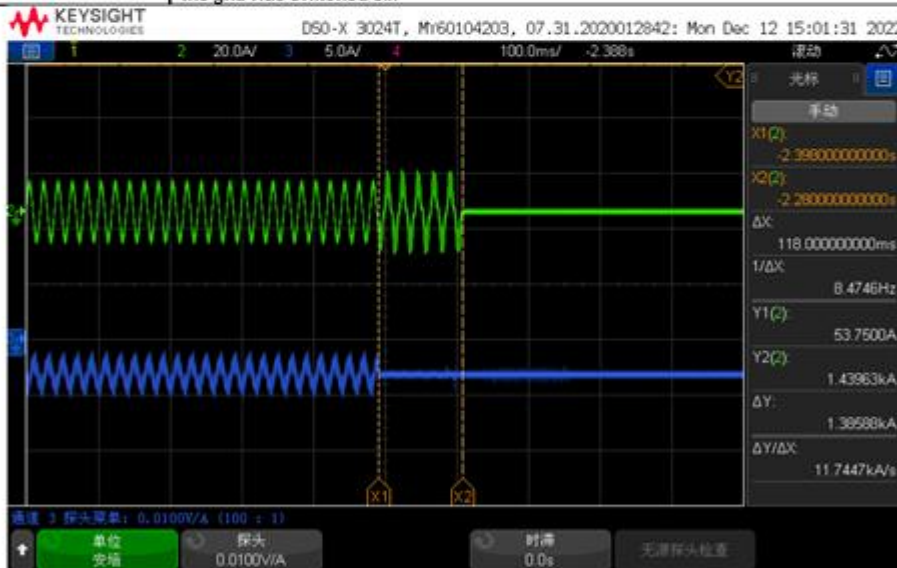

Used equipment No.: See equipment list for details Sample No.: N/A

Finished date: _____ Tested by: _____

Review date: _____ Reviewed by: _____



Compliance Evaluation Report



REPORT No.: CSSC/BOS/005

ISSUED DATE: March 9, 2023

APPENDIX C. TÜV Rheinland's Report No: CN23Y4BO 001. (Cont.)

Test Data / Test Plan		TÜVRheinland®	
TÜV Rheinland (Shanghai) Co., Ltd.		Document No.: TD-0189	
Protection and Control requirements for PEA Interface of Inverter based Generation Systems 2016.08		Report No:	CN23Y4BO 001
Order No. :	244466490	Product:	Grid-Connected PV Inverter
Client Name :	SolaX Power Network Technology (Zhejiang) Co., Ltd.	Model designation:	X1-MINI-1.5K-G4

Attachment : 1

Picture No.:	21	Clause:	7
Test:	<input checked="" type="checkbox"/> Islanding Protection <input type="checkbox"/> Secondary Over Voltage Magnitude <input type="checkbox"/> Secondary Over Voltage Trip Time <input type="checkbox"/> Secondary Under Voltage Magnitude <input type="checkbox"/> Secondary Under Voltage Trip Time <input type="checkbox"/> Under Frequency Magnitude <input type="checkbox"/> Under Frequency Trip Time		<input type="checkbox"/> First Over Voltage Magnitude <input type="checkbox"/> First Over Voltage Trip Time <input type="checkbox"/> First Under Voltage Magnitude <input type="checkbox"/> First Under Voltage Trip Time <input type="checkbox"/> Over Frequency Magnitude <input type="checkbox"/> Over Frequency Trip Time <input type="checkbox"/> Response to Utility Recovery
Test description:	100% load, PR: +5%, QC: -10%, trip time 90ms. Wave No. 1 was the output current of inverter; Wave No. 2 was the current through the grid, also regarded as trip signal while the grid was switched off.		

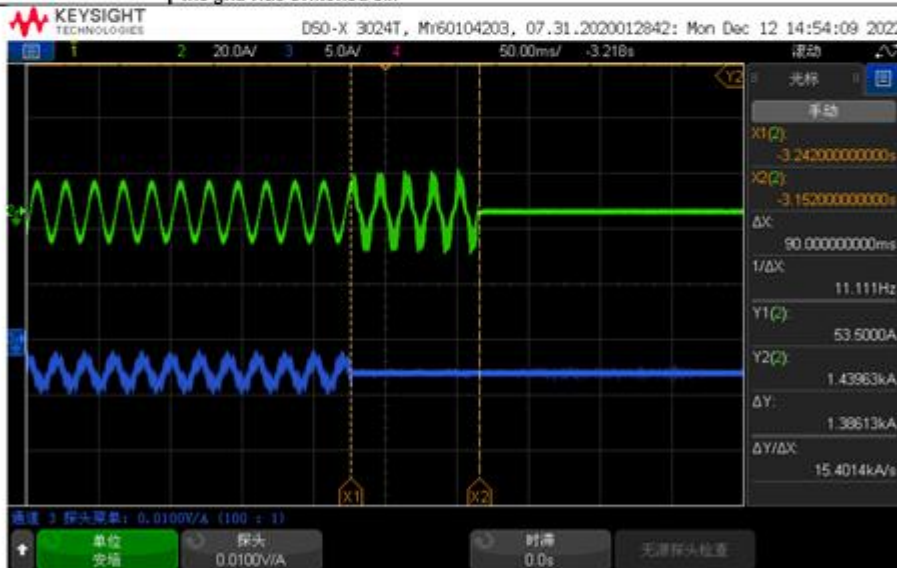

Used equipment No.: See equipment list for details Sample No.: N/A

Finished date: _____ Tested by: _____

Review date: _____ Reviewed by: _____



Compliance Evaluation Report



REPORT No.: CSSC/BOS/005

ISSUED DATE: March 9, 2023

APPENDIX C. TÜV Rheinland's Report No: CN23Y4BO 001. (Cont.)

Test Data / Test Plan		TÜVRheinland®	
TÜV Rheinland (Shanghai) Co., Ltd.		Document No.: TD-0189	
Protection and Control requirements for PEA Interface of Inverter based Generation Systems 2016.08		Report No:	CN23Y4BO 001
Order No. :	244466490	Product:	Grid-Connected PV Inverter
Client Name :	SolaX Power Network Technology (Zhejiang) Co., Ltd.	Model designation:	X1-MINI-1.5K-G4

Attachment : 1

Picture No.:	22	Clause:	7
Test:	<input checked="" type="checkbox"/> Islanding Protection <input type="checkbox"/> Secondary Over Voltage Magnitude <input type="checkbox"/> Secondary Over Voltage Trip Time <input type="checkbox"/> Secondary Under Voltage Magnitude <input type="checkbox"/> Secondary Under Voltage Trip Time <input type="checkbox"/> Under Frequency Magnitude <input type="checkbox"/> Under Frequency Trip Time	<input type="checkbox"/> First Over Voltage Magnitude <input type="checkbox"/> First Over Voltage Trip Time <input type="checkbox"/> First Under Voltage Magnitude <input type="checkbox"/> First Under Voltage Trip Time <input type="checkbox"/> Over Frequency Magnitude <input type="checkbox"/> Over Frequency Trip Time <input type="checkbox"/> Response to Utility Recovery	
Test description:	100% load, PR: +10%, QC: +10%, trip time 114ms. Wave No. 1 was the output current of inverter; Wave No. 2 was the current through the grid, also regarded as trip signal while the grid was switched off.		

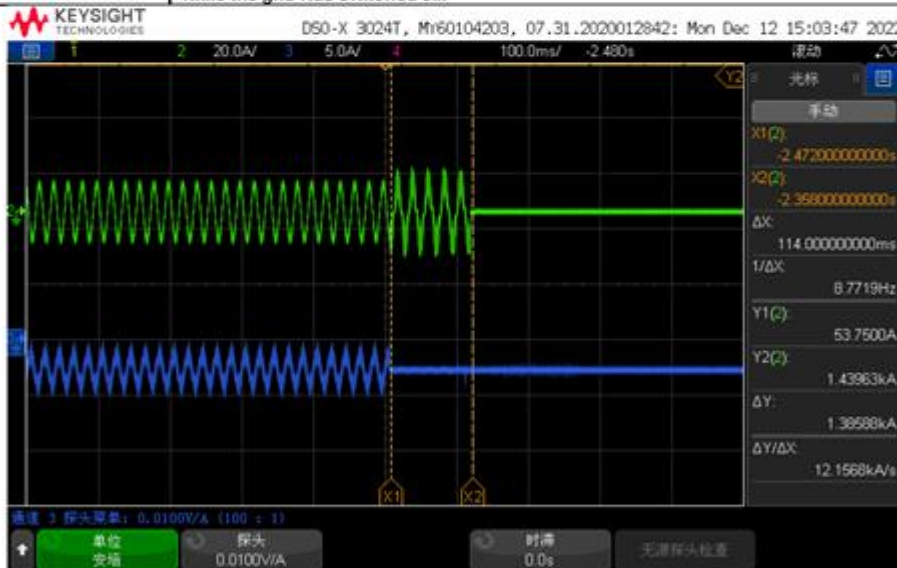

Used equipment No.: See equipment list for details Sample No.: N/A

Finished date: _____ Tested by: _____

Review date: _____ Reviewed by: _____



Compliance Evaluation Report



REPORT No.: CSSC/BOS/005

ISSUED DATE: March 9, 2023

APPENDIX C. TÜV Rheinland's Report No: CN23Y4BO 001. (Cont.)

Test Data / Test Plan		TÜVRheinland®	
TÜV Rheinland (Shanghai) Co., Ltd.		Document No.: TD-0189	
Protection and Control requirements for PEA Interface of Inverter based Generation Systems 2016.08		Report No:	CN23Y4BO 001
Order No. :	244466490	Product:	Grid-Connected PV Inverter
Client Name :	SolaX Power Network Technology (Zhejiang) Co., Ltd.	Model designation:	X1-MINI-1.5K-G4

Attachment : 1

Picture No.:	23	Clause:	7
Test:	<input checked="" type="checkbox"/> Islanding Protection <input type="checkbox"/> Secondary Over Voltage Magnitude <input type="checkbox"/> Secondary Over Voltage Trip Time <input type="checkbox"/> Secondary Under Voltage Magnitude <input type="checkbox"/> Secondary Under Voltage Trip Time <input type="checkbox"/> Under Frequency Magnitude <input type="checkbox"/> Under Frequency Trip Time		<input type="checkbox"/> First Over Voltage Magnitude <input type="checkbox"/> First Over Voltage Trip Time <input type="checkbox"/> First Under Voltage Magnitude <input type="checkbox"/> First Under Voltage Trip Time <input type="checkbox"/> Over Frequency Magnitude <input type="checkbox"/> Over Frequency Trip Time <input type="checkbox"/> Response to Utility Recovery
Test description:	100% load, PR: +10%, QC: +5%, trip time 210ms. Wave No. 1 was the output current of inverter; Wave No. 2 was the current through the grid, also regarded as trip signal while the grid was switched off.		

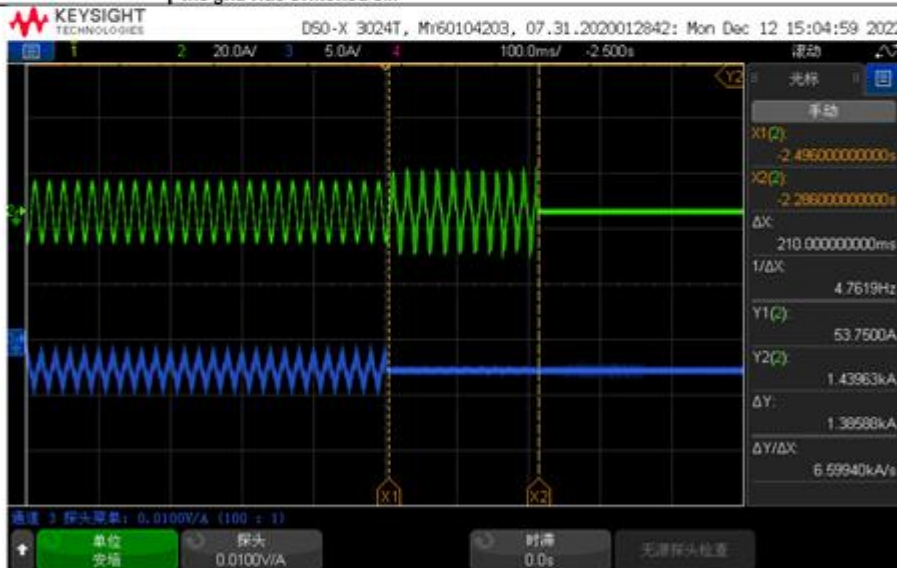

Used equipment No.: See equipment list for details Sample No.: N/A

Finished date: _____ Tested by: _____

Review date: _____ Reviewed by: _____



Compliance Evaluation Report



REPORT No.: CSSC/BOS/005

ISSUED DATE: March 9, 2023

APPENDIX C. TÜV Rheinland's Report No: CN23Y4BO 001. (Cont.)

Test Data / Test Plan		TÜVRheinland®	
TÜV Rheinland (Shanghai) Co., Ltd.		Document No.: TD-0189	
Protection and Control requirements for PEA Interface of Inverter based Generation Systems 2016.08		Report No:	CN23Y4BO 001
Order No. :	244466490	Product:	Grid-Connected PV Inverter
Client Name :	SolaX Power Network Technology (Zhejiang) Co., Ltd.	Model designation:	X1-MINI-1.5K-G4

Attachment : 1

Picture No.:	24	Clause:	7
Test:	<input checked="" type="checkbox"/> Islanding Protection <input type="checkbox"/> Secondary Over Voltage Magnitude <input type="checkbox"/> Secondary Over Voltage Trip Time <input type="checkbox"/> Secondary Under Voltage Magnitude <input type="checkbox"/> Secondary Under Voltage Trip Time <input type="checkbox"/> Under Frequency Magnitude <input type="checkbox"/> Under Frequency Trip Time		<input type="checkbox"/> First Over Voltage Magnitude <input type="checkbox"/> First Over Voltage Trip Time <input type="checkbox"/> First Under Voltage Magnitude <input type="checkbox"/> First Under Voltage Trip Time <input type="checkbox"/> Over Frequency Magnitude <input type="checkbox"/> Over Frequency Trip Time <input type="checkbox"/> Response to Utility Recovery
Test description:	100% load, PR: +10%, QC: 0%, trip time 314ms. Wave No. 1 was the output current of inverter; Wave No. 2 was the current through the grid, also regarded as trip signal while the grid was switched off.		

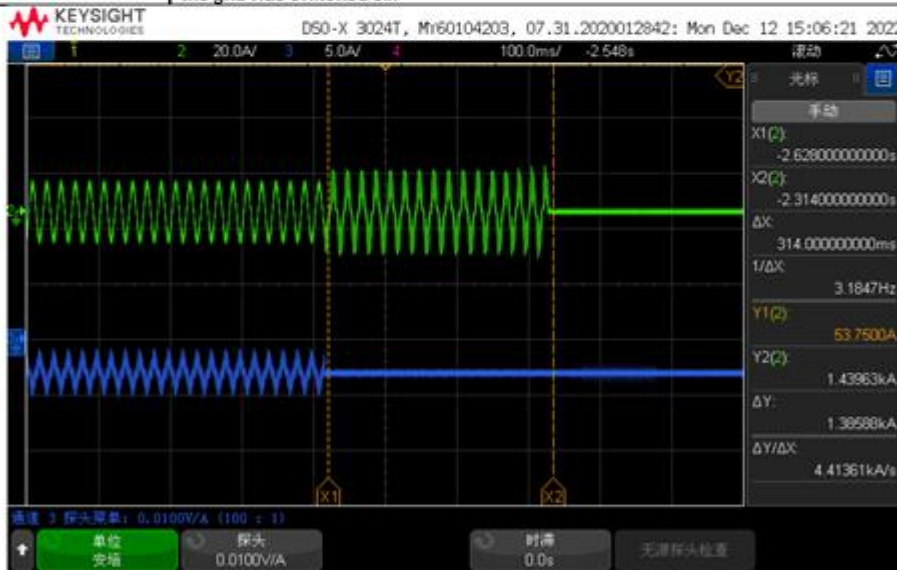

Used equipment No.: See equipment list for details Sample No.: N/A

Finished date: _____ Tested by: _____

Review date: _____ Reviewed by: _____



Compliance Evaluation Report



REPORT No.: CSSC/BOS/005

ISSUED DATE: March 9, 2023

APPENDIX C. TÜV Rheinland's Report No: CN23Y4BO 001. (Cont.)

Test Data / Test Plan		TÜVRheinland®	
TÜV Rheinland (Shanghai) Co., Ltd.		Document No.: TD-0189	
Protection and Control requirements for PEA Interface of Inverter based Generation Systems 2016.08		Report No:	CN23Y4BO 001
Order No. :	244466490	Product:	Grid-Connected PV Inverter
Client Name :	SolaX Power Network Technology (Zhejiang) Co., Ltd.	Model designation:	X1-MINI-1.5K-G4

Attachment : 1

Picture No.:	25	Clause:	7
Test:	<input checked="" type="checkbox"/> Islanding Protection <input type="checkbox"/> Secondary Over Voltage Magnitude <input type="checkbox"/> Secondary Over Voltage Trip Time <input type="checkbox"/> Secondary Under Voltage Magnitude <input type="checkbox"/> Secondary Under Voltage Trip Time <input type="checkbox"/> Under Frequency Magnitude <input type="checkbox"/> Under Frequency Trip Time		<input type="checkbox"/> First Over Voltage Magnitude <input type="checkbox"/> First Over Voltage Trip Time <input type="checkbox"/> First Under Voltage Magnitude <input type="checkbox"/> First Under Voltage Trip Time <input type="checkbox"/> Over Frequency Magnitude <input type="checkbox"/> Over Frequency Trip Time <input type="checkbox"/> Response to Utility Recovery
Test description:	100% load, PR: 10%, CC: -5%, trip time 88ms. Wave No. 1 was the output current of inverter; Wave No. 2 was the current through the grid, also regarded as trip signal while the grid was switched off.		

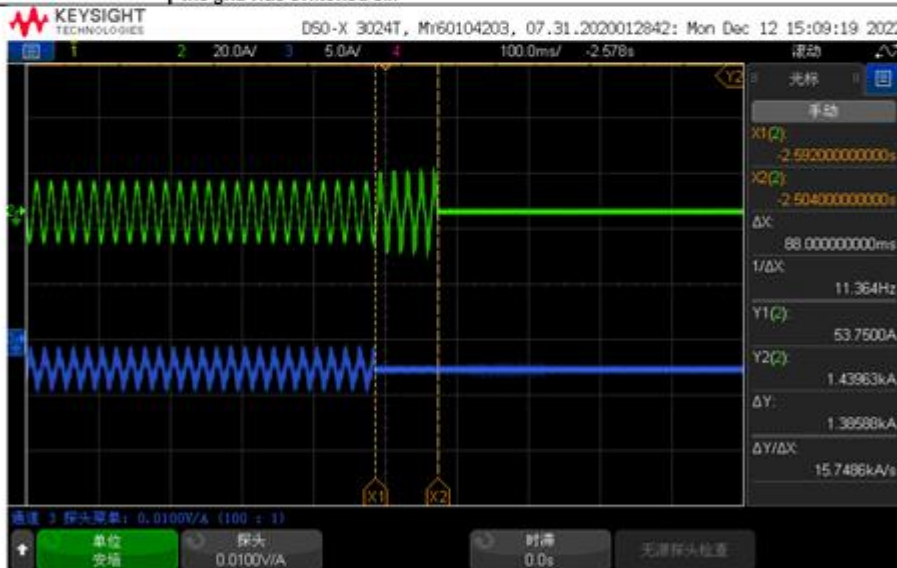

Used equipment No.: See equipment list for details Sample No.: N/A

Finished date: _____ Tested by: _____

Review date: _____ Reviewed by: _____



Compliance Evaluation Report



REPORT No.: CSSC/BOS/005

ISSUED DATE: March 9, 2023

APPENDIX C. TÜV Rheinland's Report No: CN23Y4BO 001. (Cont.)

Test Data / Test Plan		TÜVRheinland®	
TÜV Rheinland (Shanghai) Co., Ltd.		Document No.: TD-0189	
Protection and Control requirements for PEA Interface of Inverter based Generation Systems 2016.08		Report No:	CN23Y4BO 001
Order No. :	244466490	Product:	Grid-Connected PV Inverter
Client Name :	SolaX Power Network Technology (Zhejiang) Co., Ltd.	Model designation:	X1-MINI-1.5K-G4

Attachment : 1

Picture No.:	26	Clause:	7
Test:	<input checked="" type="checkbox"/> Islanding Protection <input type="checkbox"/> Secondary Over Voltage Magnitude <input type="checkbox"/> Secondary Over Voltage Trip Time <input type="checkbox"/> Secondary Under Voltage Magnitude <input type="checkbox"/> Secondary Under Voltage Trip Time <input type="checkbox"/> Under Frequency Magnitude <input type="checkbox"/> Under Frequency Trip Time	<input type="checkbox"/> First Over Voltage Magnitude <input type="checkbox"/> First Over Voltage Trip Time <input type="checkbox"/> First Under Voltage Magnitude <input type="checkbox"/> First Under Voltage Trip Time <input type="checkbox"/> Over Frequency Magnitude <input type="checkbox"/> Over Frequency Trip Time <input type="checkbox"/> Response to Utility Recovery	
Test description:	100% load, PR: +10%, QC: -10%, trip time 78ms. Wave No. 1 was the output current of inverter; Wave No. 2 was the current through the grid, also regarded as trip signal while the grid was switched off.		

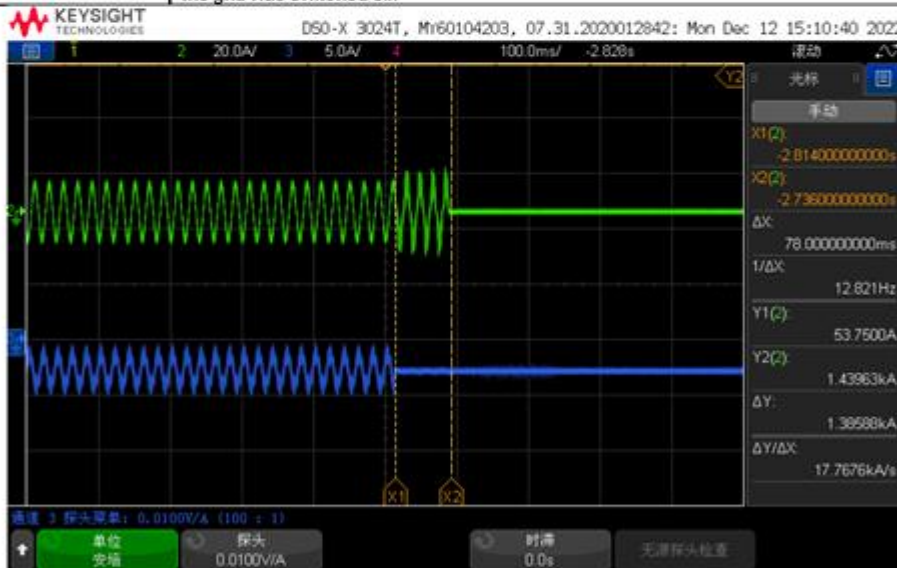

Used equipment No.: See equipment list for details Sample No.: N/A

Finished date: _____ Tested by: _____

Review date: _____ Reviewed by: _____



Compliance Evaluation Report



REPORT No.: CSSC/BOS/005

ISSUED DATE: March 9, 2023

APPENDIX C. TÜV Rheinland's Report No: CN23Y4BO 001. (Cont.)

Test Data / Test Plan		TÜVRheinland®	
TÜV Rheinland (Shanghai) Co., Ltd.		Document No.: TD-0189	
Protection and Control requirements for PEA Interface of Inverter based Generation Systems 2016.08		Report No:	CN23Y4BO 001
Order No. :	244466490	Product:	Grid-Connected PV Inverter
Client Name :	SolaX Power Network Technology (Zhejiang) Co., Ltd.	Model designation:	X1-MINI-1.5K-G4

Attachment : 1

Picture No.:	27	Clause:	7
Test:	<input checked="" type="checkbox"/> Islanding Protection <input type="checkbox"/> Secondary Over Voltage Magnitude <input type="checkbox"/> Secondary Over Voltage Trip Time <input type="checkbox"/> Secondary Under Voltage Magnitude <input type="checkbox"/> Secondary Under Voltage Trip Time <input type="checkbox"/> Under Frequency Magnitude <input type="checkbox"/> Under Frequency Trip Time	<input type="checkbox"/> First Over Voltage Magnitude <input type="checkbox"/> First Over Voltage Trip Time <input type="checkbox"/> First Under Voltage Magnitude <input type="checkbox"/> First Under Voltage Trip Time <input type="checkbox"/> Over Frequency Magnitude <input type="checkbox"/> Over Frequency Trip Time <input type="checkbox"/> Response to Utility Recovery	
Test description:	66% load, PR: 0%, QC: -5%, trip time 132ms. Wave No. 1 was the output current of inverter; Wave No. 2 was the current through the grid, also regarded as trip signal while the grid was switched off.		

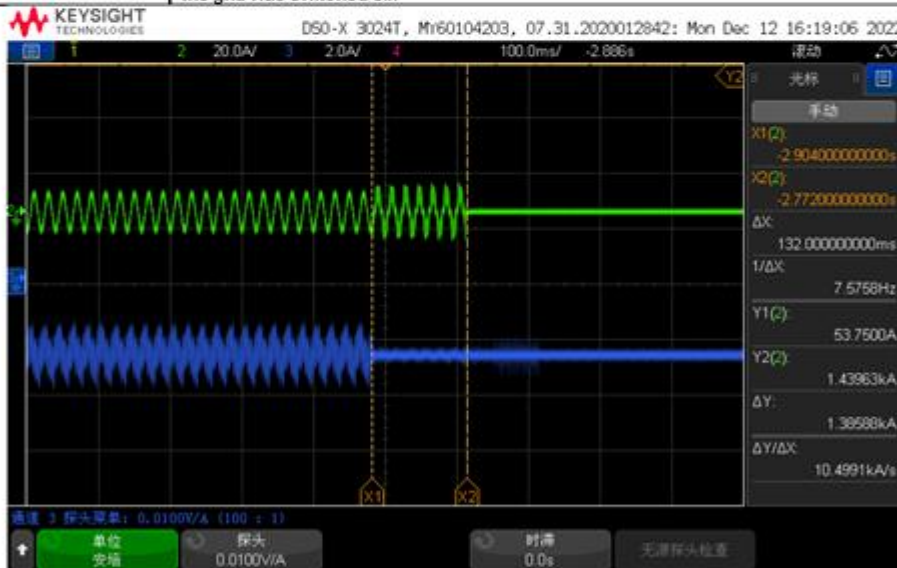

Used equipment No.: See equipment list for details Sample No.: N/A

Finished date: _____ Tested by: _____

Review date: _____ Reviewed by: _____



Compliance Evaluation Report



REPORT No.: CSSC/BOS/005

ISSUED DATE: March 9, 2023

APPENDIX C. TÜV Rheinland's Report No: CN23Y4BO 001. (Cont.)

Test Data / Test Plan		TÜVRheinland®	
TÜV Rheinland (Shanghai) Co., Ltd.		Document No.: TD-0189	
Protection and Control requirements for PEA Interface of Inverter based Generation Systems 2016.08		Report No:	CN23Y4BO 001
Order No. :	244466490	Product:	Grid-Connected PV Inverter
Client Name :	SolaX Power Network Technology (Zhejiang) Co., Ltd.	Model designation:	X1-MINI-1.5K-G4

Attachment : 1

Picture No.:	28	Clause:	7
Test:	<input checked="" type="checkbox"/> Islanding Protection <input type="checkbox"/> Secondary Over Voltage Magnitude <input type="checkbox"/> Secondary Over Voltage Trip Time <input type="checkbox"/> Secondary Under Voltage Magnitude <input type="checkbox"/> Secondary Under Voltage Trip Time <input type="checkbox"/> Under Frequency Magnitude <input type="checkbox"/> Under Frequency Trip Time	<input type="checkbox"/> First Over Voltage Magnitude <input type="checkbox"/> First Over Voltage Trip Time <input type="checkbox"/> First Under Voltage Magnitude <input type="checkbox"/> First Under Voltage Trip Time <input type="checkbox"/> Over Frequency Magnitude <input type="checkbox"/> Over Frequency Trip Time <input type="checkbox"/> Response to Utility Recovery	
Test description:	66% load, PR: 0%, QC: -4%, Trip time 146ms. Wave No. 1 was the output current of inverter; Wave No. 2 was the current through the grid, also regarded as trip signal while the grid was switched off.		

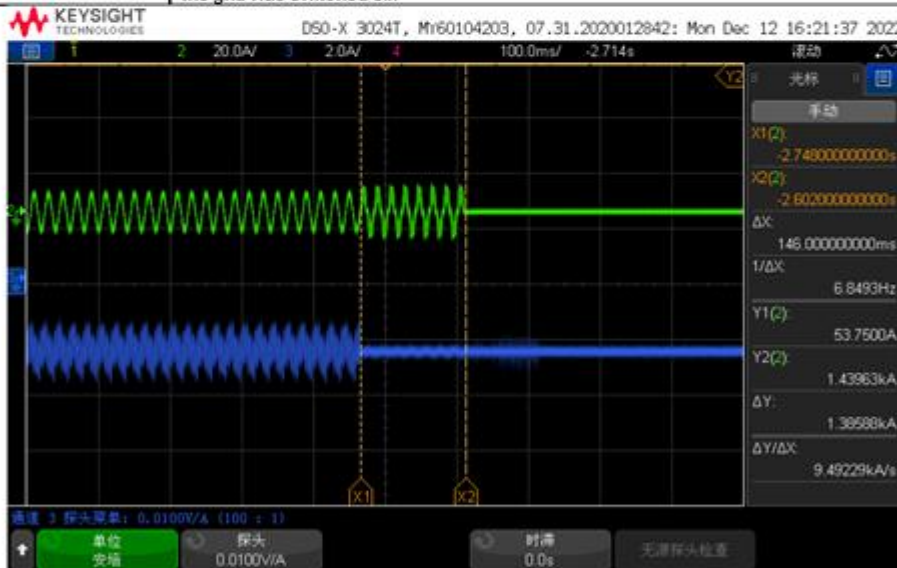

Used equipment No.: See equipment list for details Sample No.: N/A

Finished date: _____ Tested by: _____

Review date: _____ Reviewed by: _____



Compliance Evaluation Report



REPORT No.: CSSC/BOS/005

ISSUED DATE: March 9, 2023

APPENDIX C. TÜV Rheinland's Report No: CN23Y4BO 001. (Cont.)

Test Data / Test Plan		TÜVRheinland®	
TÜV Rheinland (Shanghai) Co., Ltd.		Document No.: TD-0189	
Protection and Control requirements for PEA Interface of Inverter based Generation Systems 2016.08		Report No:	CN23Y4BO 001
Order No. :	244466490	Product:	Grid-Connected PV Inverter
Client Name :	SolaX Power Network Technology (Zhejiang) Co., Ltd.	Model designation:	X1-MINI-1.5K-G4

Attachment : 1

Picture No.:	29	Clause:	7
Test:	<input checked="" type="checkbox"/> Islanding Protection <input type="checkbox"/> Secondary Over Voltage Magnitude <input type="checkbox"/> Secondary Over Voltage Trip Time <input type="checkbox"/> Secondary Under Voltage Magnitude <input type="checkbox"/> Secondary Under Voltage Trip Time <input type="checkbox"/> Under Frequency Magnitude <input type="checkbox"/> Under Frequency Trip Time	<input type="checkbox"/> First Over Voltage Magnitude <input type="checkbox"/> First Over Voltage Trip Time <input type="checkbox"/> First Under Voltage Magnitude <input type="checkbox"/> First Under Voltage Trip Time <input type="checkbox"/> Over Frequency Magnitude <input type="checkbox"/> Over Frequency Trip Time <input type="checkbox"/> Response to Utility Recovery	
Test description:	66% load, PR: 0%, QC: -3%, Trip time 286ms. Wave No. 1 was the output current of inverter; Wave No. 2 was the current through the grid, also regarded as trip signal while the grid was switched off.		

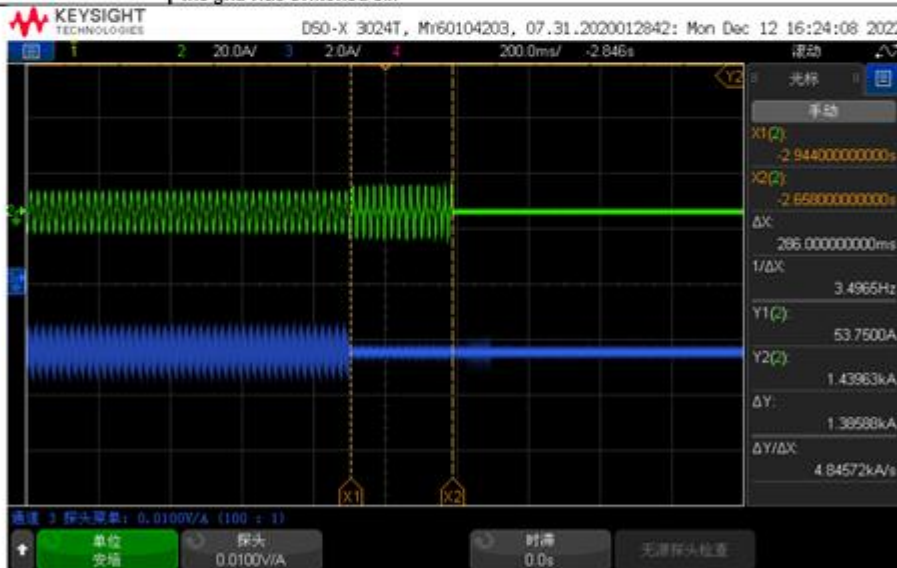

Used equipment No.: See equipment list for details Sample No.: N/A

Finished date: _____ Tested by: _____

Review date: _____ Reviewed by: _____



Compliance Evaluation Report



REPORT No.: CSSC/BOS/005

ISSUED DATE: March 9, 2023

APPENDIX C. TÜV Rheinland's Report No: CN23Y4BO 001. (Cont.)

Test Data / Test Plan		TÜVRheinland®	
TÜV Rheinland (Shanghai) Co., Ltd.		Document No.: TD-0189	
Protection and Control requirements for PEA Interface of Inverter based Generation Systems 2016.08		Report No:	CN23Y4BO 001
Order No. :	244466490	Product:	Grid-Connected PV Inverter
Client Name :	SolaX Power Network Technology (Zhejiang) Co., Ltd.	Model designation:	X1-MINI-1.5K-G4

Attachment : 1

Picture No.:	30	Clause:	7
Test:	<input checked="" type="checkbox"/> Islanding Protection <input type="checkbox"/> Secondary Over Voltage Magnitude <input type="checkbox"/> Secondary Over Voltage Trip Time <input type="checkbox"/> Secondary Under Voltage Magnitude <input type="checkbox"/> Secondary Under Voltage Trip Time <input type="checkbox"/> Under Frequency Magnitude <input type="checkbox"/> Under Frequency Trip Time		<input type="checkbox"/> First Over Voltage Magnitude <input type="checkbox"/> First Over Voltage Trip Time <input type="checkbox"/> First Under Voltage Magnitude <input type="checkbox"/> First Under Voltage Trip Time <input type="checkbox"/> Over Frequency Magnitude <input type="checkbox"/> Over Frequency Trip Time <input type="checkbox"/> Response to Utility Recovery
Test description:	66% load, PR: 0%, QC: -2%, trip time 138ms. Wave No. 1 was the output current of inverter; Wave No. 2 was the current through the grid, also regarded as trip signal while the grid was switched off.		

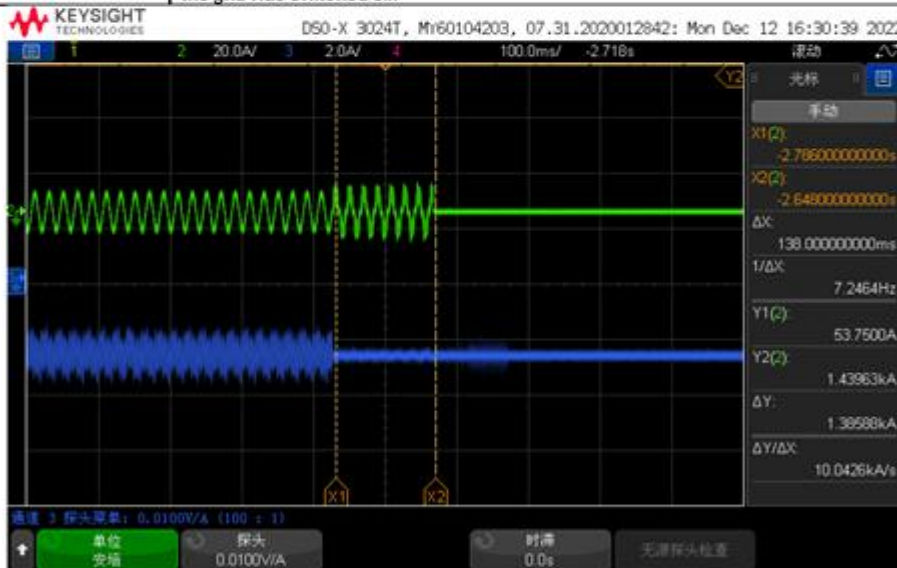

Used equipment No.: See equipment list for details Sample No.: N/A

Finished date: _____ Tested by: _____

Review date: _____ Reviewed by: _____



Compliance Evaluation Report



REPORT No.: CSSC/BOS/005

ISSUED DATE: March 9, 2023

APPENDIX C. TÜV Rheinland's Report No: CN23Y4BO 001. (Cont.)

Test Data / Test Plan		TÜVRheinland®	
TÜV Rheinland (Shanghai) Co., Ltd.		Document No.: TD-0189	
Protection and Control requirements for PEA Interface of Inverter based Generation Systems 2016.08		Report No:	CN23Y4BO 001
Order No. :	244466490	Product:	Grid-Connected PV Inverter
Client Name :	SolaX Power Network Technology (Zhejiang) Co., Ltd.	Model designation:	X1-MINI-1.5K-G4

Attachment : 1

Picture No.:	31	Clause:	7
Test:	<input checked="" type="checkbox"/> Islanding Protection <input type="checkbox"/> Secondary Over Voltage Magnitude <input type="checkbox"/> Secondary Over Voltage Trip Time <input type="checkbox"/> Secondary Under Voltage Magnitude <input type="checkbox"/> Secondary Under Voltage Trip Time <input type="checkbox"/> Under Frequency Magnitude <input type="checkbox"/> Under Frequency Trip Time		<input type="checkbox"/> First Over Voltage Magnitude <input type="checkbox"/> First Over Voltage Trip Time <input type="checkbox"/> First Under Voltage Magnitude <input type="checkbox"/> First Under Voltage Trip Time <input type="checkbox"/> Over Frequency Magnitude <input type="checkbox"/> Over Frequency Trip Time <input type="checkbox"/> Response to Utility Recovery
Test description:	66% load, PR: 0%, QC: -1%, trip time 212ms. Wave No. 1 was the output current of inverter; Wave No. 2 was the current through the grid, also regarded as trip signal while the grid was switched off.		

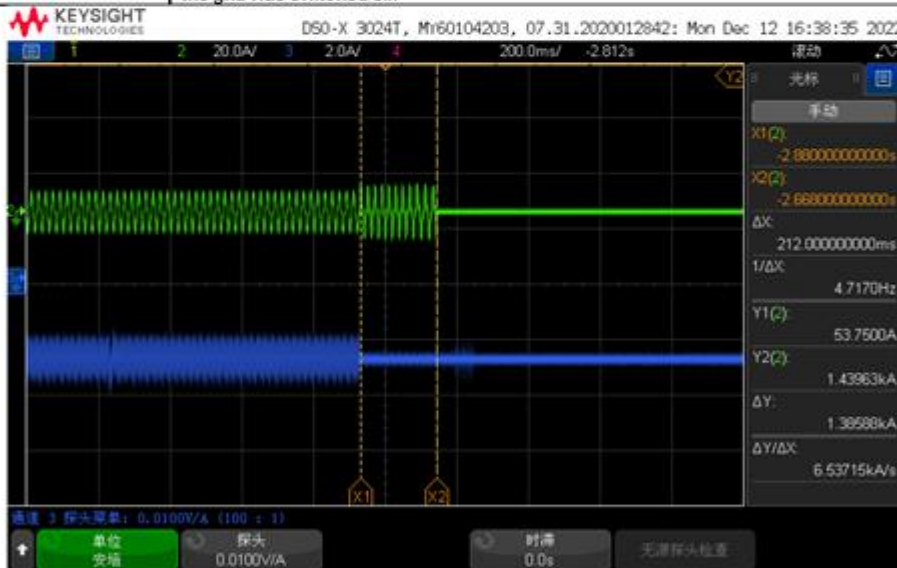

Used equipment No.: See equipment list for details Sample No.: N/A

Finished date: _____ Tested by: _____

Review date: _____ Reviewed by: _____



Compliance Evaluation Report



REPORT No.: CSSC/BOS/005

ISSUED DATE: March 9, 2023

APPENDIX C. TÜV Rheinland's Report No: CN23Y4BO 001. (Cont.)

Test Data / Test Plan			
TÜV Rheinland (Shanghai) Co., Ltd.		Document No.: TD-0189	
Protection and Control requirements for PEA Interface of Inverter based Generation Systems 2016.08		Report No:	CN23Y4BO 001
Order No. :	244466490	Product:	Grid-Connected PV Inverter
Client Name :	SolaX Power Network Technology (Zhejiang) Co., Ltd.	Model designation:	X1-MINI-1.5K-G4

Attachment : 1

Picture No.:	32	Clause:	7
Test:	<input checked="" type="checkbox"/> Islanding Protection <input type="checkbox"/> Secondary Over Voltage Magnitude <input type="checkbox"/> Secondary Over Voltage Trip Time <input type="checkbox"/> Secondary Under Voltage Magnitude <input type="checkbox"/> Secondary Under Voltage Trip Time <input type="checkbox"/> Under Frequency Magnitude <input type="checkbox"/> Under Frequency Trip Time <input type="checkbox"/> First Over Voltage Magnitude <input type="checkbox"/> First Over Voltage Trip Time <input type="checkbox"/> First Under Voltage Magnitude <input type="checkbox"/> First Under Voltage Trip Time <input type="checkbox"/> Over Frequency Magnitude <input type="checkbox"/> Over Frequency Trip Time <input type="checkbox"/> Response to Utility Recovery		
Test description:	66% load, PR: 0%, QC: 0%, trip time 348ms. Wave No. 1 was the output current of inverter; Wave No. 2 was the current through the grid, also regarded as trip signal while the grid was switched off.		

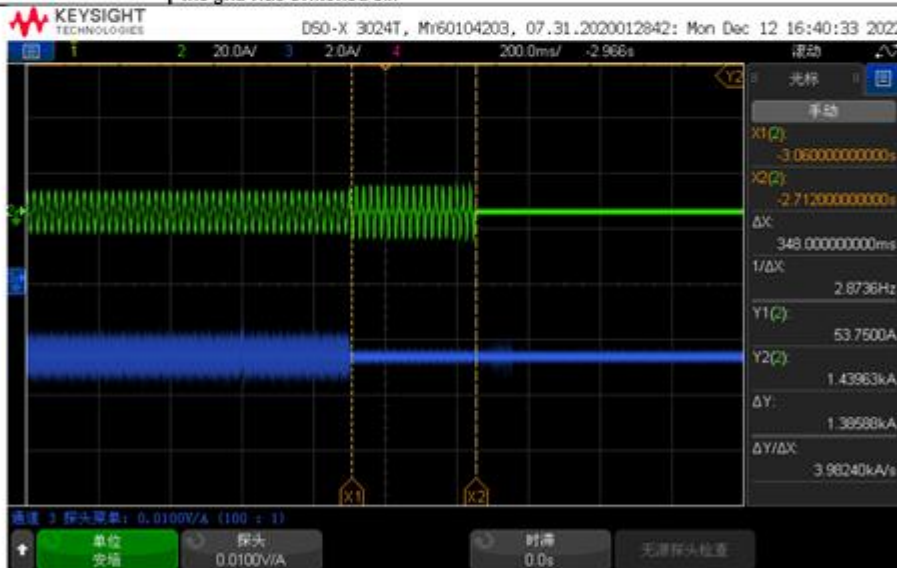

Used equipment No.: See equipment list for details Sample No.: N/A

Finished date: _____ Tested by: _____

Review date: _____ Reviewed by: _____



Compliance Evaluation Report



REPORT No.: CSSC/BOS/005

ISSUED DATE: March 9, 2023

APPENDIX C. TÜV Rheinland's Report No: CN23Y4BO 001. (Cont.)

Test Data / Test Plan			
TÜV Rheinland (Shanghai) Co., Ltd.		Document No.: TD-0189	
Protection and Control requirements for PEA Interface of Inverter based Generation Systems 2016.08		Report No:	CN23Y4BO 001
Order No. :	244466490	Product:	Grid-Connected PV Inverter
Client Name :	SolaX Power Network Technology (Zhejiang) Co., Ltd.	Model designation:	X1-MINI-1.5K-G4

Attachment : 1

Picture No.:	33	Clause:	7
Test:	<input checked="" type="checkbox"/> Islanding Protection <input type="checkbox"/> Secondary Over Voltage Magnitude <input type="checkbox"/> Secondary Over Voltage Trip Time <input type="checkbox"/> Secondary Under Voltage Magnitude <input type="checkbox"/> Secondary Under Voltage Trip Time <input type="checkbox"/> Under Frequency Magnitude <input type="checkbox"/> Under Frequency Trip Time <input type="checkbox"/> First Over Voltage Magnitude <input type="checkbox"/> First Over Voltage Trip Time <input type="checkbox"/> First Under Voltage Magnitude <input type="checkbox"/> First Under Voltage Trip Time <input type="checkbox"/> Over Frequency Magnitude <input type="checkbox"/> Over Frequency Trip Time <input type="checkbox"/> Response to Utility Recovery		
Test description:	At the balance condition of 66% load, the fundamental magnitude of grid current(1 st harmonic) was 0.009A, less than 1% of rating current 0.068A. See screenshot of power analyzer for detail.		

X1-Mini-G4

	相1		三相总和	
U_tRMS	220.09	V	220.09	V
I_tRMS	156.04	mA	156.04	mA
P_t	1.2685	W	1.2685	W
Q_t	34.112	var	34.112	var
S_t	34.342	VA	34.342	VA
PF_t	0.0303		0.0303	
F_fund			50.000	Hz
U_fundRMS	220.09	V	220.09	V
I_fundRMS	9.0957	mA	9.0957	mA
P_fund	1.2529	W	1.2529	W
Q_fund	-9.8478	mvar	-9.8478	mvar
S_fund	2.0019	VA	2.0019	VA

Used equipment No.:	See equipment list for details	Sample No.:	N/A
Finished date:	_____	Tested by:	_____
Review date:	_____	Reviewed by:	_____



Compliance Evaluation Report



REPORT No.: CSSC/BOS/005

ISSUED DATE: March 9, 2023

APPENDIX C. TÜV Rheinland's Report No: CN23Y4BO 001. (Cont.)

Test Data / Test Plan			
TÜV Rheinland (Shanghai) Co., Ltd.		Document No.: TD-0189	
Protection and Control requirements for PEA Interface of Inverter based Generation Systems 2016.08		Report No:	CN23Y4BO 001
Order No. :	244466490	Product:	Grid-Connected PV Inverter
Client Name :	SolaX Power Network Technology (Zhejiang) Co., Ltd.	Model designation:	X1-MINI-1.5K-G4

Attachment : 1

Picture No.:	34	Clause:	7
Test:	<input checked="" type="checkbox"/> Islanding Protection <input type="checkbox"/> Secondary Over Voltage Magnitude <input type="checkbox"/> Secondary Over Voltage Trip Time <input type="checkbox"/> Secondary Under Voltage Magnitude <input type="checkbox"/> Secondary Under Voltage Trip Time <input type="checkbox"/> Under Frequency Magnitude <input type="checkbox"/> Under Frequency Trip Time <input type="checkbox"/> First Over Voltage Magnitude <input type="checkbox"/> First Over Voltage Trip Time <input type="checkbox"/> First Under Voltage Magnitude <input type="checkbox"/> First Under Voltage Trip Time <input type="checkbox"/> Over Frequency Magnitude <input type="checkbox"/> Over Frequency Trip Time <input type="checkbox"/> Response to Utility Recovery		
Test description:	66% load, PR: 0%, QC: +1%, trip time 294ms. Wave No. 1 was the output current of inverter; Wave No. 2 was the current through the grid, also regarded as trip signal while the grid was switched off.		

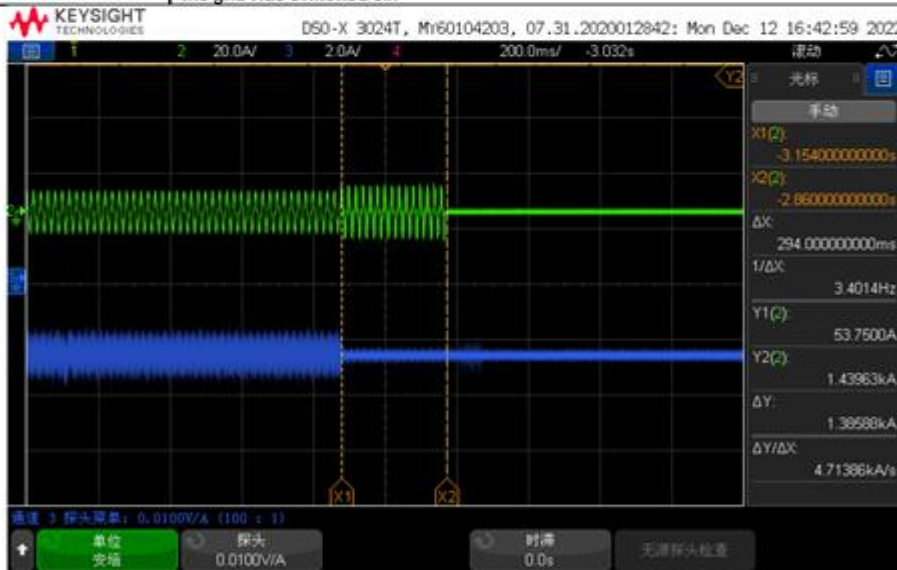

Used equipment No.: See equipment list for details Sample No.: N/A

Finished date: _____ Tested by: _____

Review date: _____ Reviewed by: _____



Compliance Evaluation Report



REPORT No.: CSSC/BOS/005

ISSUED DATE: March 9, 2023

APPENDIX C. TÜV Rheinland's Report No: CN23Y4BO 001. (Cont.)

Test Data / Test Plan		TÜVRheinland®	
TÜV Rheinland (Shanghai) Co., Ltd.		Document No.: TD-0189	
Protection and Control requirements for PEA Interface of Inverter based Generation Systems 2016.08		Report No:	CN23Y4BO 001
Order No. :	244466490	Product:	Grid-Connected PV Inverter
Client Name :	SolaX Power Network Technology (Zhejiang) Co., Ltd.	Model designation:	X1-MINI-1.5K-G4

Attachment : 1

Picture No.:	35	Clause:	7
Test:	<input checked="" type="checkbox"/> Islanding Protection <input type="checkbox"/> Secondary Over Voltage Magnitude <input type="checkbox"/> Secondary Over Voltage Trip Time <input type="checkbox"/> Secondary Under Voltage Magnitude <input type="checkbox"/> Secondary Under Voltage Trip Time <input type="checkbox"/> Under Frequency Magnitude <input type="checkbox"/> Under Frequency Trip Time	<input type="checkbox"/> First Over Voltage Magnitude <input type="checkbox"/> First Over Voltage Trip Time <input type="checkbox"/> First Under Voltage Magnitude <input type="checkbox"/> First Under Voltage Trip Time <input type="checkbox"/> Over Frequency Magnitude <input type="checkbox"/> Over Frequency Trip Time <input type="checkbox"/> Response to Utility Recovery	
Test description:	66% load, PR: 0%, QC: +2%, trip time 368ms. Wave No. 1 was the output current of inverter; Wave No. 2 was the current through the grid, also regarded as trip signal while the grid was switched off.		

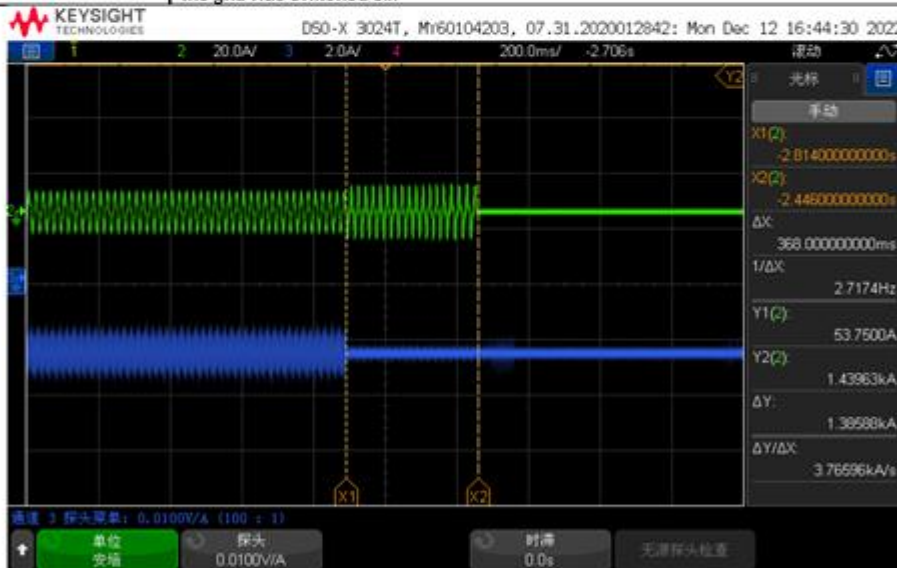

Used equipment No.: See equipment list for details Sample No.: N/A

Finished date: _____ Tested by: _____

Review date: _____ Reviewed by: _____



Compliance Evaluation Report



REPORT No.: CSSC/BOS/005

ISSUED DATE: March 9, 2023

APPENDIX C. TÜV Rheinland's Report No: CN23Y4BO 001. (Cont.)

Test Data / Test Plan		TÜVRheinland®	
TÜV Rheinland (Shanghai) Co., Ltd.		Document No.: TD-0189	
Protection and Control requirements for PEA Interface of Inverter based Generation Systems 2016.08		Report No:	CN23Y4BO 001
Order No. :	244466490	Product:	Grid-Connected PV Inverter
Client Name :	SolaX Power Network Technology (Zhejiang) Co., Ltd.	Model designation:	X1-MINI-1.5K-G4

Attachment : 1

Picture No.:	36	Clause:	7
Test:	<input checked="" type="checkbox"/> Islanding Protection <input type="checkbox"/> Secondary Over Voltage Magnitude <input type="checkbox"/> Secondary Over Voltage Trip Time <input type="checkbox"/> Secondary Under Voltage Magnitude <input type="checkbox"/> Secondary Under Voltage Trip Time <input type="checkbox"/> Under Frequency Magnitude <input type="checkbox"/> Under Frequency Trip Time		<input type="checkbox"/> First Over Voltage Magnitude <input type="checkbox"/> First Over Voltage Trip Time <input type="checkbox"/> First Under Voltage Magnitude <input type="checkbox"/> First Under Voltage Trip Time <input type="checkbox"/> Over Frequency Magnitude <input type="checkbox"/> Over Frequency Trip Time <input type="checkbox"/> Response to Utility Recovery
Test description:	66% load, PR: 0%, QC: +3%, trip time 262ms. Wave No. 1 was the output current of inverter; Wave No. 2 was the current through the grid, also regarded as trip signal while the grid was switched off.		

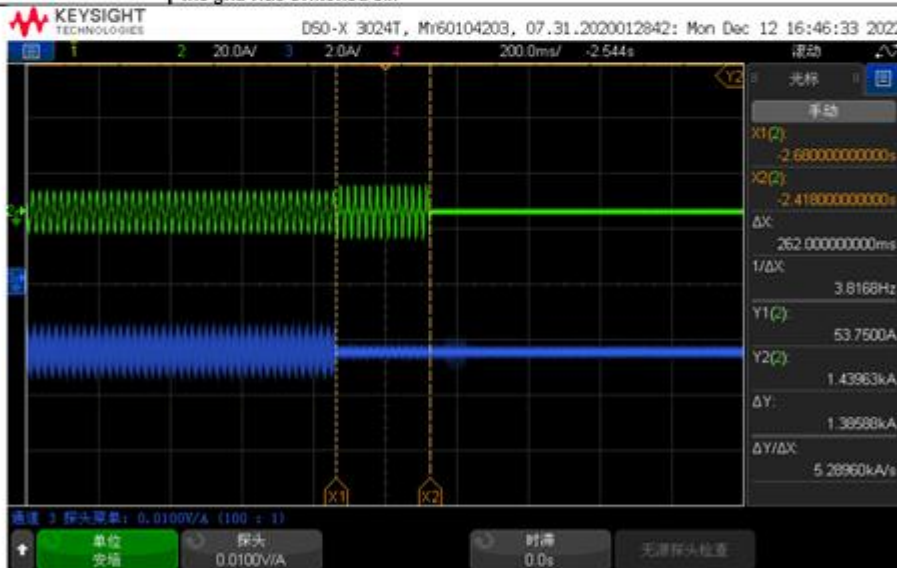

Used equipment No.: See equipment list for details Sample No.: N/A

Finished date: _____ Tested by: _____

Review date: _____ Reviewed by: _____



Compliance Evaluation Report



REPORT No.: CSSC/BOS/005

ISSUED DATE: March 9, 2023

APPENDIX C. TÜV Rheinland's Report No: CN23Y4BO 001. (Cont.)

Test Data / Test Plan			
TÜV Rheinland (Shanghai) Co., Ltd.		Document No.: TD-0189	
Protection and Control requirements for PEA Interface of Inverter based Generation Systems 2016.08		Report No:	CN23Y4BO 001
Order No. :	244466490	Product:	Grid-Connected PV Inverter
Client Name :	SolaX Power Network Technology (Zhejiang) Co., Ltd.	Model designation:	X1-MINI-1.5K-G4

Attachment : 1

Picture No.:	37	Clause:	7
Test:	<input checked="" type="checkbox"/> Islanding Protection <input type="checkbox"/> Secondary Over Voltage Magnitude <input type="checkbox"/> Secondary Over Voltage Trip Time <input type="checkbox"/> Secondary Under Voltage Magnitude <input type="checkbox"/> Secondary Under Voltage Trip Time <input type="checkbox"/> Under Frequency Magnitude <input type="checkbox"/> Under Frequency Trip Time <input type="checkbox"/> First Over Voltage Magnitude <input type="checkbox"/> First Over Voltage Trip Time <input type="checkbox"/> First Under Voltage Magnitude <input type="checkbox"/> First Under Voltage Trip Time <input type="checkbox"/> Over Frequency Magnitude <input type="checkbox"/> Over Frequency Trip Time <input type="checkbox"/> Response to Utility Recovery		
Test description:	66% load, PR: 0%, QC: +4%, trip time 340ms. Wave No. 1 was the output current of inverter; Wave No. 2 was the current through the grid, also regarded as trip signal while the grid was switched off.		

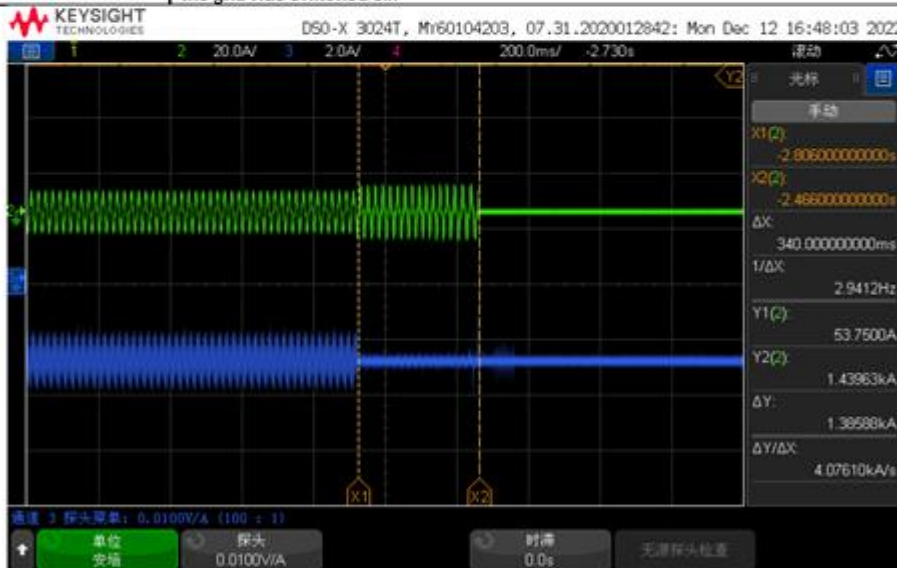

Used equipment No.: See equipment list for details Sample No.: N/A

Finished date: _____ Tested by: _____

Review date: _____ Reviewed by: _____



Compliance Evaluation Report



REPORT No.: CSSC/BOS/005

ISSUED DATE: March 9, 2023

APPENDIX C. TÜV Rheinland's Report No: CN23Y4BO 001. (Cont.)

Test Data / Test Plan		TÜVRheinland®	
TÜV Rheinland (Shanghai) Co., Ltd.		Document No.: TD-0189	
Protection and Control requirements for PEA Interface of Inverter based Generation Systems 2016.08		Report No:	CN23Y4BO 001
Order No. :	244466490	Product:	Grid-Connected PV Inverter
Client Name :	SolaX Power Network Technology (Zhejiang) Co., Ltd.	Model designation:	X1-MINI-1.5K-G4

Attachment : 1

Picture No.:	38	Clause:	7
Test:	<input checked="" type="checkbox"/> Islanding Protection <input type="checkbox"/> Secondary Over Voltage Magnitude <input type="checkbox"/> Secondary Over Voltage Trip Time <input type="checkbox"/> Secondary Under Voltage Magnitude <input type="checkbox"/> Secondary Under Voltage Trip Time <input type="checkbox"/> Under Frequency Magnitude <input type="checkbox"/> Under Frequency Trip Time		<input type="checkbox"/> First Over Voltage Magnitude <input type="checkbox"/> First Over Voltage Trip Time <input type="checkbox"/> First Under Voltage Magnitude <input type="checkbox"/> First Under Voltage Trip Time <input type="checkbox"/> Over Frequency Magnitude <input type="checkbox"/> Over Frequency Trip Time <input type="checkbox"/> Response to Utility Recovery
Test description:	66% load, PR: 0%, QC: +5%, trip time 252ms. Wave No. 1 was the output current of inverter; Wave No. 2 was the current through the grid, also regarded as trip signal while the grid was switched off.		

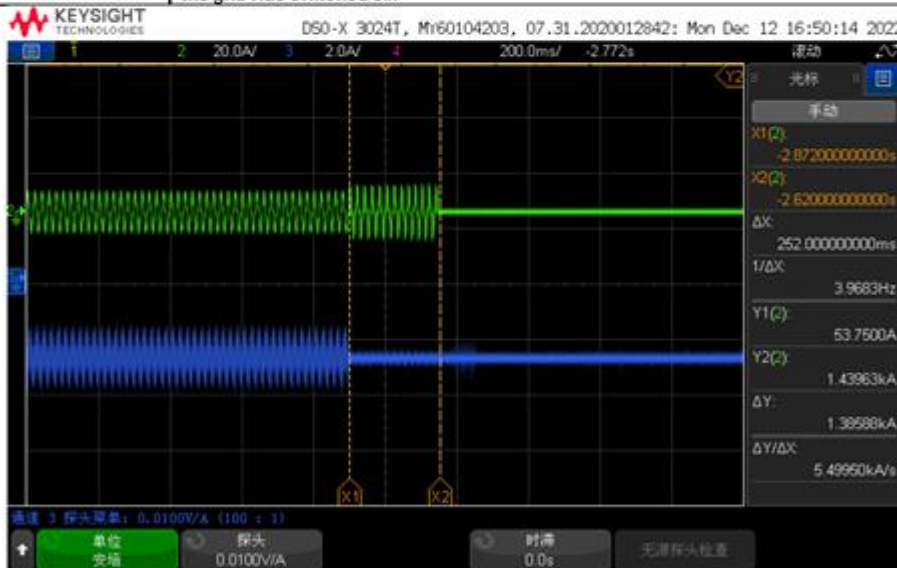

Used equipment No.: See equipment list for details Sample No.: N/A

Finished date: _____ Tested by: _____

Review date: _____ Reviewed by: _____



Compliance Evaluation Report



REPORT No.: CSSC/BOS/005

ISSUED DATE: March 9, 2023

APPENDIX C. TÜV Rheinland's Report No: CN23Y4BO 001. (Cont.)

Test Data / Test Plan		TÜVRheinland®	
TÜV Rheinland (Shanghai) Co., Ltd.		Document No.: TD-0189	
Protection and Control requirements for PEA Interface of Inverter based Generation Systems 2016.08		Report No:	CN23Y4BO 001
Order No. :	244466490	Product:	Grid-Connected PV Inverter
Client Name :	SolaX Power Network Technology (Zhejiang) Co., Ltd.	Model designation:	X1-MINI-1.5K-G4

Attachment : 1

Picture No.:	39	Clause:	7
Test:	<input checked="" type="checkbox"/> Islanding Protection <input type="checkbox"/> Secondary Over Voltage Magnitude <input type="checkbox"/> Secondary Over Voltage Trip Time <input type="checkbox"/> Secondary Under Voltage Magnitude <input type="checkbox"/> Secondary Under Voltage Trip Time <input type="checkbox"/> Under Frequency Magnitude <input type="checkbox"/> Under Frequency Trip Time	<input type="checkbox"/> First Over Voltage Magnitude <input type="checkbox"/> First Over Voltage Trip Time <input type="checkbox"/> First Under Voltage Magnitude <input type="checkbox"/> First Under Voltage Trip Time <input type="checkbox"/> Over Frequency Magnitude <input type="checkbox"/> Over Frequency Trip Time <input type="checkbox"/> Response to Utility Recovery	
Test description:	33% load, PR: 0%, QC: -5%, trip time 308ms. Wave No. 1 was the output current of inverter; Wave No. 2 was the current through the grid, also regarded as trip signal while the grid was switched off.		

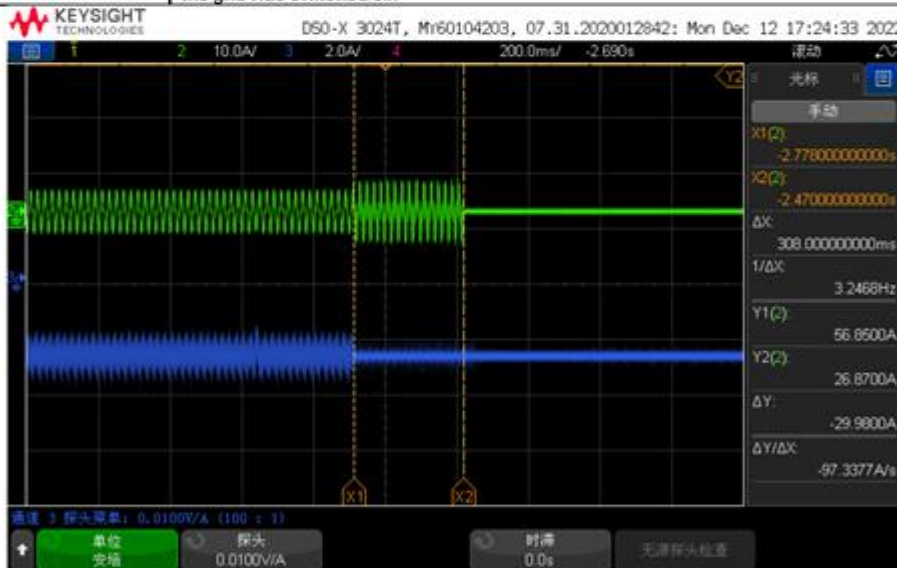

Used equipment No.: See equipment list for details Sample No.: N/A

Finished date: _____ Tested by: _____

Review date: _____ Reviewed by: _____



Compliance Evaluation Report



REPORT No.: CSSC/BOS/005

ISSUED DATE: March 9, 2023

APPENDIX C. TÜV Rheinland's Report No: CN23Y4BO 001. (Cont.)

Test Data / Test Plan		TÜVRheinland®	
TÜV Rheinland (Shanghai) Co., Ltd.		Document No.: TD-0189	
Protection and Control requirements for PEA Interface of Inverter based Generation Systems 2016.08		Report No:	CN23Y4BO 001
Order No. :	244466490	Product:	Grid-Connected PV Inverter
Client Name :	SolaX Power Network Technology (Zhejiang) Co., Ltd.	Model designation:	X1-MINI-1.5K-G4

Attachment : 1

Picture No.:	40	Clause:	7
Test:	<input checked="" type="checkbox"/> Islanding Protection <input type="checkbox"/> Secondary Over Voltage Magnitude <input type="checkbox"/> Secondary Over Voltage Trip Time <input type="checkbox"/> Secondary Under Voltage Magnitude <input type="checkbox"/> Secondary Under Voltage Trip Time <input type="checkbox"/> Under Frequency Magnitude <input type="checkbox"/> Under Frequency Trip Time		<input type="checkbox"/> First Over Voltage Magnitude <input type="checkbox"/> First Over Voltage Trip Time <input type="checkbox"/> First Under Voltage Magnitude <input type="checkbox"/> First Under Voltage Trip Time <input type="checkbox"/> Over Frequency Magnitude <input type="checkbox"/> Over Frequency Trip Time <input type="checkbox"/> Response to Utility Recovery
Test description:	33% load, PR: 0%, QC: -4%, trip time 310ms. Wave No. 1 was the output current of inverter; Wave No. 2 was the current through the grid, also regarded as trip signal while the grid was switched off.		

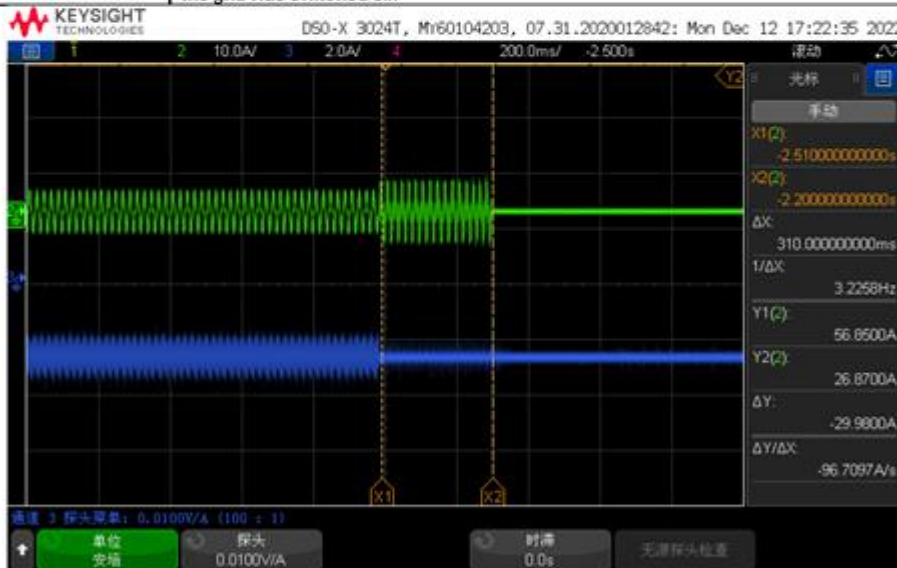

Used equipment No.: See equipment list for details Sample No.: N/A

Finished date: _____ Tested by: _____

Review date: _____ Reviewed by: _____



Compliance Evaluation Report



REPORT No.: CSSC/BOS/005

ISSUED DATE: March 9, 2023

APPENDIX C. TÜV Rheinland's Report No: CN23Y4BO 001. (Cont.)

Test Data / Test Plan		TÜVRheinland®	
TÜV Rheinland (Shanghai) Co., Ltd.		Document No.: TD-0189	
Protection and Control requirements for PEA Interface of Inverter based Generation Systems 2016.08		Report No:	CN23Y4BO 001
Order No. :	244466490	Product:	Grid-Connected PV Inverter
Client Name :	SolaX Power Network Technology (Zhejiang) Co., Ltd.	Model designation:	X1-MINI-1.5K-G4

Attachment : 1

Picture No.:	41	Clause:	7
Test:	<input checked="" type="checkbox"/> Islanding Protection <input type="checkbox"/> Secondary Over Voltage Magnitude <input type="checkbox"/> Secondary Over Voltage Trip Time <input type="checkbox"/> Secondary Under Voltage Magnitude <input type="checkbox"/> Secondary Under Voltage Trip Time <input type="checkbox"/> Under Frequency Magnitude <input type="checkbox"/> Under Frequency Trip Time		<input type="checkbox"/> First Over Voltage Magnitude <input type="checkbox"/> First Over Voltage Trip Time <input type="checkbox"/> First Under Voltage Magnitude <input type="checkbox"/> First Under Voltage Trip Time <input type="checkbox"/> Over Frequency Magnitude <input type="checkbox"/> Over Frequency Trip Time <input type="checkbox"/> Response to Utility Recovery
Test description:	33% load, PR: 0%, QC: -3%, Trip time 148ms. Wave No. 1 was the output current of inverter; Wave No. 2 was the current through the grid, also regarded as trip signal while the grid was switched off.		

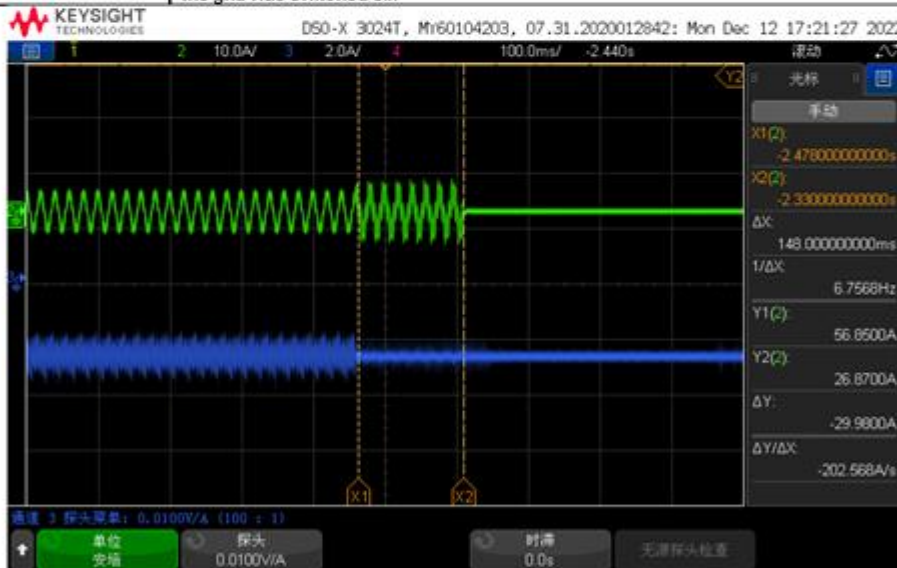

Used equipment No.: See equipment list for details Sample No.: N/A

Finished date: _____ Tested by: _____

Review date: _____ Reviewed by: _____



Compliance Evaluation Report



REPORT No.: CSSC/BOS/005

ISSUED DATE: March 9, 2023

APPENDIX C. TÜV Rheinland's Report No: CN23Y4BO 001. (Cont.)

Test Data / Test Plan		TÜVRheinland®	
TÜV Rheinland (Shanghai) Co., Ltd.		Document No.: TD-0189	
Protection and Control requirements for PEA Interface of Inverter based Generation Systems 2016.08		Report No:	CN23Y4BO 001
Order No. :	244466490	Product:	Grid-Connected PV Inverter
Client Name :	SolaX Power Network Technology (Zhejiang) Co., Ltd.	Model designation:	X1-MINI-1.5K-G4

Attachment : 1

Picture No.:	42	Clause:	7
Test:	<input checked="" type="checkbox"/> Islanding Protection <input type="checkbox"/> Secondary Over Voltage Magnitude <input type="checkbox"/> Secondary Over Voltage Trip Time <input type="checkbox"/> Secondary Under Voltage Magnitude <input type="checkbox"/> Secondary Under Voltage Trip Time <input type="checkbox"/> Under Frequency Magnitude <input type="checkbox"/> Under Frequency Trip Time	<input type="checkbox"/> First Over Voltage Magnitude <input type="checkbox"/> First Over Voltage Trip Time <input type="checkbox"/> First Under Voltage Magnitude <input type="checkbox"/> First Under Voltage Trip Time <input type="checkbox"/> Over Frequency Magnitude <input type="checkbox"/> Over Frequency Trip Time <input type="checkbox"/> Response to Utility Recovery	
Test description:	33% load, PR: 0%, QC: -2%, trip time 138ms. Wave No. 1 was the output current of inverter; Wave No. 2 was the current through the grid, also regarded as trip signal while the grid was switched off.		

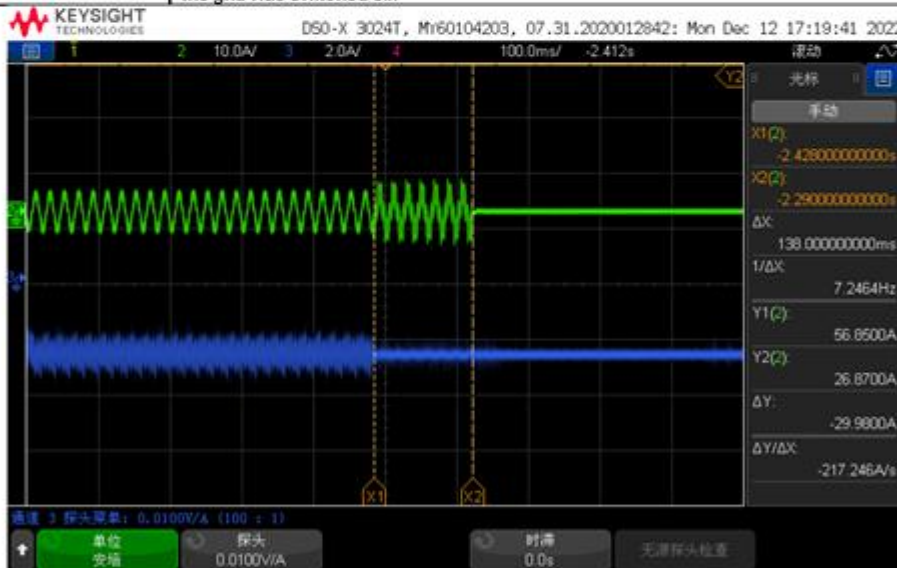

Used equipment No.: See equipment list for details Sample No.: N/A

Finished date: _____ Tested by: _____

Review date: _____ Reviewed by: _____



Compliance Evaluation Report



REPORT No.: CSSC/BOS/005

ISSUED DATE: March 9, 2023

APPENDIX C. TÜV Rheinland's Report No: CN23Y4BO 001. (Cont.)

Test Data / Test Plan		TÜVRheinland®	
TÜV Rheinland (Shanghai) Co., Ltd.		Document No.: TD-0189	
Protection and Control requirements for PEA Interface of Inverter based Generation Systems 2016.08		Report No:	CN23Y4BO 001
Order No. :	244466490	Product:	Grid-Connected PV Inverter
Client Name :	SolaX Power Network Technology (Zhejiang) Co., Ltd.	Model designation:	X1-MINI-1.5K-G4

Attachment : 1

Picture No.:	43	Clause:	7
Test:	<input checked="" type="checkbox"/> Islanding Protection <input type="checkbox"/> Secondary Over Voltage Magnitude <input type="checkbox"/> Secondary Over Voltage Trip Time <input type="checkbox"/> Secondary Under Voltage Magnitude <input type="checkbox"/> Secondary Under Voltage Trip Time <input type="checkbox"/> Under Frequency Magnitude <input type="checkbox"/> Under Frequency Trip Time	<input type="checkbox"/> First Over Voltage Magnitude <input type="checkbox"/> First Over Voltage Trip Time <input type="checkbox"/> First Under Voltage Magnitude <input type="checkbox"/> First Under Voltage Trip Time <input type="checkbox"/> Over Frequency Magnitude <input type="checkbox"/> Over Frequency Trip Time <input type="checkbox"/> Response to Utility Recovery	
Test description:	33% load, PR: 0%, QC: -1%, trip time 146ms. Wave No. 1 was the output current of inverter; Wave No. 2 was the current through the grid, also regarded as trip signal while the grid was switched off.		

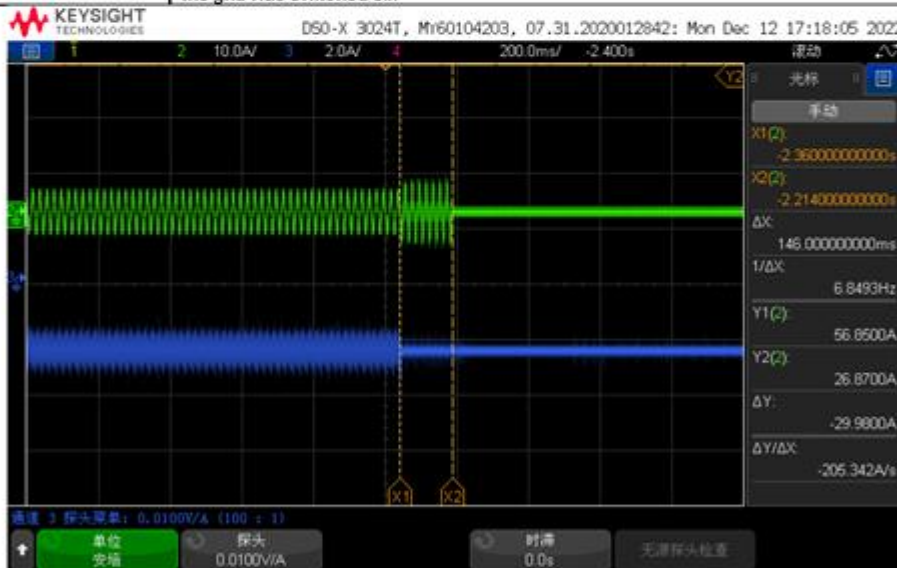

Used equipment No.: See equipment list for details Sample No.: N/A

Finished date: _____ Tested by: _____

Review date: _____ Reviewed by: _____



Compliance Evaluation Report



REPORT No.: CSSC/BOS/005

ISSUED DATE: March 9, 2023

APPENDIX C. TÜV Rheinland's Report No: CN23Y4BO 001. (Cont.)

Test Data / Test Plan		TÜVRheinland®	
TÜV Rheinland (Shanghai) Co., Ltd.		Document No.: TD-0189	
Protection and Control requirements for PEA Interface of Inverter based Generation Systems 2016.08		Report No:	CN23Y4BO 001
Order No. :	244466490	Product:	Grid-Connected PV Inverter
Client Name :	SolaX Power Network Technology (Zhejiang) Co., Ltd.	Model designation:	X1-MINI-1.5K-G4

Attachment : 1

Picture No.:	44	Clause:	7
Test:	<input checked="" type="checkbox"/> Islanding Protection <input type="checkbox"/> Secondary Over Voltage Magnitude <input type="checkbox"/> Secondary Over Voltage Trip Time <input type="checkbox"/> Secondary Under Voltage Magnitude <input type="checkbox"/> Secondary Under Voltage Trip Time <input type="checkbox"/> Under Frequency Magnitude <input type="checkbox"/> Under Frequency Trip Time		<input type="checkbox"/> First Over Voltage Magnitude <input type="checkbox"/> First Over Voltage Trip Time <input type="checkbox"/> First Under Voltage Magnitude <input type="checkbox"/> First Under Voltage Trip Time <input type="checkbox"/> Over Frequency Magnitude <input type="checkbox"/> Over Frequency Trip Time <input type="checkbox"/> Response to Utility Recovery
Test description:	33% load, PR: 0%, QC: 0%, trip time 342ms. Wave No. 1 was the output current of inverter; Wave No. 2 was the current through the grid, also regarded as trip signal while the grid was switched off.		

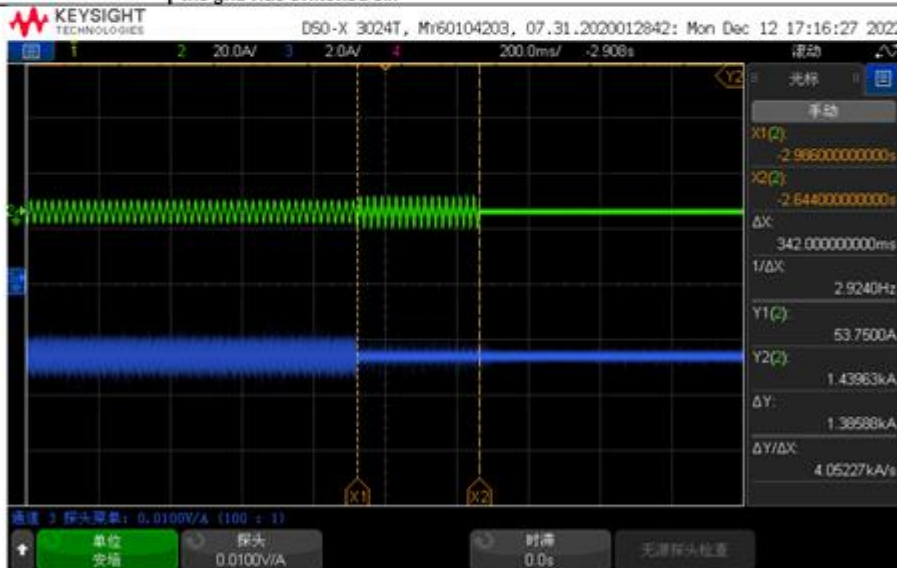

Used equipment No.: See equipment list for details Sample No.: N/A

Finished date: _____ Tested by: _____

Review date: _____ Reviewed by: _____



Compliance Evaluation Report



REPORT No.: CSSC/BOS/005

ISSUED DATE: March 9, 2023

APPENDIX C. TÜV Rheinland's Report No: CN23Y4BO 001. (Cont.)

Test Data / Test Plan		TÜVRheinland®	
TÜV Rheinland (Shanghai) Co., Ltd.		Document No.: TD-0189	
Protection and Control requirements for PEA Interface of Inverter based Generation Systems 2016.08		Report No:	CN23Y4BO 001
Order No. :	244466490	Product:	Grid-Connected PV Inverter
Client Name :	SolaX Power Network Technology (Zhejiang) Co., Ltd.	Model designation:	X1-MINI-1.5K-G4

Attachment : 1

Picture No.:	45	Clause:	7
Test:	<input checked="" type="checkbox"/> Islanding Protection <input type="checkbox"/> Secondary Over Voltage Magnitude <input type="checkbox"/> Secondary Over Voltage Trip Time <input type="checkbox"/> Secondary Under Voltage Magnitude <input type="checkbox"/> Secondary Under Voltage Trip Time <input type="checkbox"/> Under Frequency Magnitude <input type="checkbox"/> Under Frequency Trip Time <input type="checkbox"/> First Over Voltage Magnitude <input type="checkbox"/> First Over Voltage Trip Time <input type="checkbox"/> First Under Voltage Magnitude <input type="checkbox"/> First Under Voltage Trip Time <input type="checkbox"/> Over Frequency Magnitude <input type="checkbox"/> Over Frequency Trip Time <input type="checkbox"/> Response to Utility Recovery		
Test description:	At the balance condition of 33% load, the fundamental magnitude of grid current (1 st harmonic) was 0.011A, less than 1% of rated current 0.068A. See screenshot of power analyzer for detail.		

X1-Mini-G4

	相 1		三相总和	
U_tRMS	220.06	V	220.06	V
I_tRMS	120.02	mA	120.02	mA
P_t	1.0739	W	1.0739	W
Q_t	26.217	var	26.217	var
S_t	26.411	VA	26.411	VA
PF_t	0.0398		0.0398	
F_fund			50.000	Hz
U_fundRMS	220.06	V	220.06	V
I_fundRMS	11.755	mA	11.755	mA
P_fund	1.0598	W	1.0598	W
Q_fund	1.0552	var	1.0552	var
S_fund	2.5867	VA	2.5867	VA

Used equipment No.: See equipment list for details Sample No.: N/A

Finished date: _____ Tested by: _____

Review date: _____ Reviewed by: _____



Compliance Evaluation Report



REPORT No.: CSSC/BOS/005

ISSUED DATE: March 9, 2023

APPENDIX C. TÜV Rheinland's Report No: CN23Y4BO 001. (Cont.)

Test Data / Test Plan		TÜVRheinland®	
TÜV Rheinland (Shanghai) Co., Ltd.		Document No.: TD-0189	
Protection and Control requirements for PEA Interface of Inverter based Generation Systems 2016.08		Report No:	CN23Y4BO 001
Order No. :	244466490	Product:	Grid-Connected PV Inverter
Client Name :	SolaX Power Network Technology (Zhejiang) Co., Ltd.	Model designation:	X1-MINI-1.5K-G4

Attachment : 1

Picture No.:	46	Clause:	7
Test:	<input checked="" type="checkbox"/> Islanding Protection <input type="checkbox"/> Secondary Over Voltage Magnitude <input type="checkbox"/> Secondary Over Voltage Trip Time <input type="checkbox"/> Secondary Under Voltage Magnitude <input type="checkbox"/> Secondary Under Voltage Trip Time <input type="checkbox"/> Under Frequency Magnitude <input type="checkbox"/> Under Frequency Trip Time		<input type="checkbox"/> First Over Voltage Magnitude <input type="checkbox"/> First Over Voltage Trip Time <input type="checkbox"/> First Under Voltage Magnitude <input type="checkbox"/> First Under Voltage Trip Time <input type="checkbox"/> Over Frequency Magnitude <input type="checkbox"/> Over Frequency Trip Time <input type="checkbox"/> Response to Utility Recovery
Test description:	33% load, PR: 0%, QC: +1%, trip time 4/8ms. Wave No. 1 was the output current of inverter; Wave No. 2 was the current through the grid, also regarded as trip signal while the grid was switched off.		

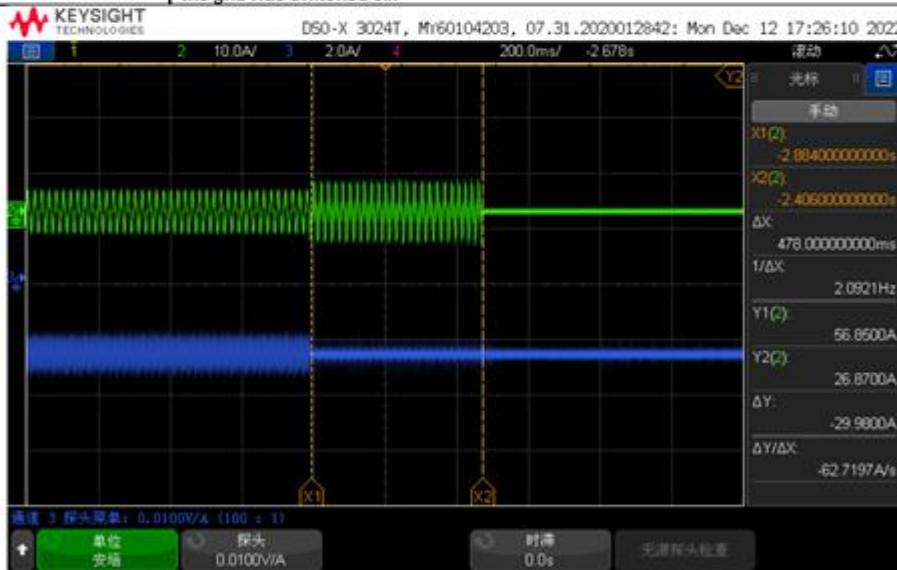

Used equipment No.: See equipment list for details Sample No.: N/A

Finished date: _____ Tested by: _____

Review date: _____ Reviewed by: _____



Compliance Evaluation Report



REPORT No.: CSSC/BOS/005

ISSUED DATE: March 9, 2023

APPENDIX C. TÜV Rheinland's Report No: CN23Y4BO 001. (Cont.)

Test Data / Test Plan		TÜVRheinland®	
TÜV Rheinland (Shanghai) Co., Ltd.		Document No.: TD-0189	
Protection and Control requirements for PEA Interface of Inverter based Generation Systems 2016.08		Report No:	CN23Y4BO 001
Order No. :	244466490	Product:	Grid-Connected PV Inverter
Client Name :	SolaX Power Network Technology (Zhejiang) Co., Ltd.	Model designation:	X1-MINI-1.5K-G4

Attachment : 1

Picture No.:	47	Clause:	7
Test:	<input checked="" type="checkbox"/> Islanding Protection <input type="checkbox"/> Secondary Over Voltage Magnitude <input type="checkbox"/> Secondary Over Voltage Trip Time <input type="checkbox"/> Secondary Under Voltage Magnitude <input type="checkbox"/> Secondary Under Voltage Trip Time <input type="checkbox"/> Under Frequency Magnitude <input type="checkbox"/> Under Frequency Trip Time		<input type="checkbox"/> First Over Voltage Magnitude <input type="checkbox"/> First Over Voltage Trip Time <input type="checkbox"/> First Under Voltage Magnitude <input type="checkbox"/> First Under Voltage Trip Time <input type="checkbox"/> Over Frequency Magnitude <input type="checkbox"/> Over Frequency Trip Time <input type="checkbox"/> Response to Utility Recovery
Test description:	33% load, PR: 0%, QC: +2%, trip time 388ms. Wave No. 1 was the output current of inverter; Wave No. 2 was the current through the grid, also regarded as trip signal while the grid was switched off.		

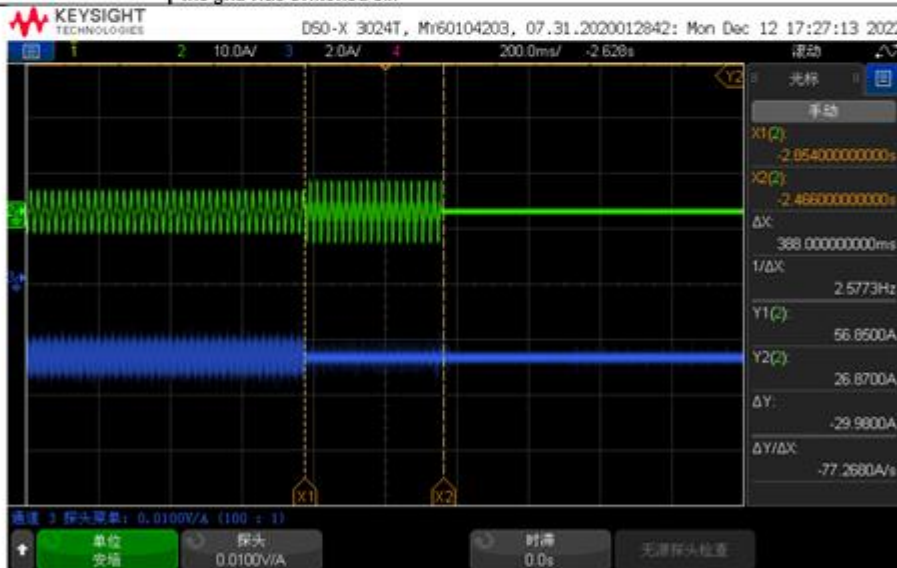

Used equipment No.: See equipment list for details Sample No.: N/A

Finished date: _____ Tested by: _____

Review date: _____ Reviewed by: _____



Compliance Evaluation Report



REPORT No.: CSSC/BOS/005

ISSUED DATE: March 9, 2023

APPENDIX C. TÜV Rheinland's Report No: CN23Y4BO 001. (Cont.)

Test Data / Test Plan		TÜVRheinland®	
TÜV Rheinland (Shanghai) Co., Ltd.		Document No.: TD-0189	
Protection and Control requirements for PEA Interface of Inverter based Generation Systems 2016.08		Report No:	CN23Y4BO 001
Order No. :	244466490	Product:	Grid-Connected PV Inverter
Client Name :	SolaX Power Network Technology (Zhejiang) Co., Ltd.	Model designation:	X1-MINI-1.5K-G4

Attachment : 1

Picture No.:	48	Clause:	7
Test:	<input checked="" type="checkbox"/> Islanding Protection <input type="checkbox"/> Secondary Over Voltage Magnitude <input type="checkbox"/> Secondary Over Voltage Trip Time <input type="checkbox"/> Secondary Under Voltage Magnitude <input type="checkbox"/> Secondary Under Voltage Trip Time <input type="checkbox"/> Under Frequency Magnitude <input type="checkbox"/> Under Frequency Trip Time		<input type="checkbox"/> First Over Voltage Magnitude <input type="checkbox"/> First Over Voltage Trip Time <input type="checkbox"/> First Under Voltage Magnitude <input type="checkbox"/> First Under Voltage Trip Time <input type="checkbox"/> Over Frequency Magnitude <input type="checkbox"/> Over Frequency Trip Time <input type="checkbox"/> Response to Utility Recovery
Test description:	33% load, PR: 0%, QC: +3%, trip time 358ms. Wave No. 1 was the output current of inverter; Wave No. 2 was the current through the grid, also regarded as trip signal while the grid was switched off.		

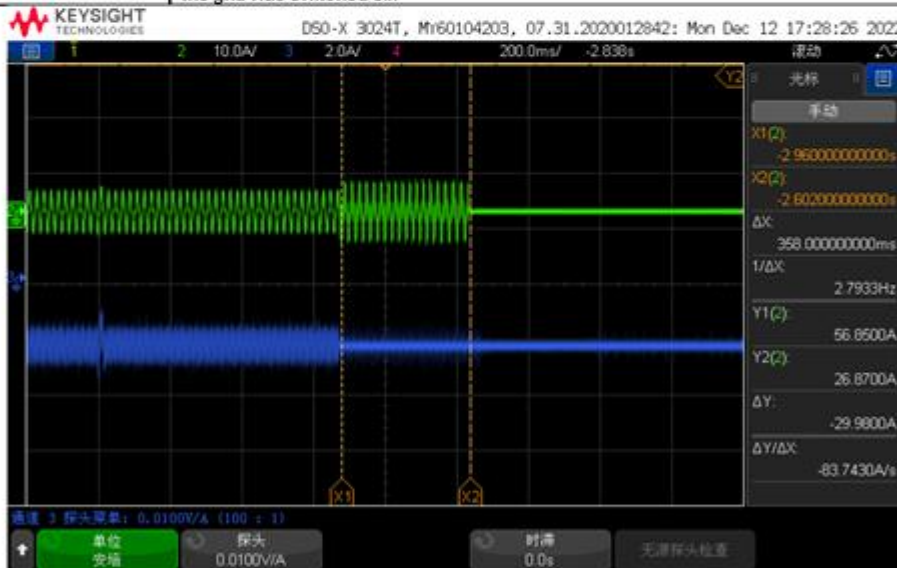

Used equipment No.: See equipment list for details Sample No.: N/A

Finished date: _____ Tested by: _____

Review date: _____ Reviewed by: _____



Compliance Evaluation Report



REPORT No.: CSSC/BOS/005

ISSUED DATE: March 9, 2023

APPENDIX C. TÜV Rheinland's Report No: CN23Y4BO 001. (Cont.)

Test Data / Test Plan		TÜVRheinland®	
TÜV Rheinland (Shanghai) Co., Ltd.		Document No.: TD-0189	
Protection and Control requirements for PEA Interface of Inverter based Generation Systems 2016.08		Report No:	CN23Y4BO 001
Order No. :	244466490	Product:	Grid-Connected PV Inverter
Client Name :	SolaX Power Network Technology (Zhejiang) Co., Ltd.	Model designation:	X1-MINI-1.5K-G4

Attachment : 1

Picture No.:	49	Clause:	7
Test:	<input checked="" type="checkbox"/> Islanding Protection <input type="checkbox"/> Secondary Over Voltage Magnitude <input type="checkbox"/> Secondary Over Voltage Trip Time <input type="checkbox"/> Secondary Under Voltage Magnitude <input type="checkbox"/> Secondary Under Voltage Trip Time <input type="checkbox"/> Under Frequency Magnitude <input type="checkbox"/> Under Frequency Trip Time	<input type="checkbox"/> First Over Voltage Magnitude <input type="checkbox"/> First Over Voltage Trip Time <input type="checkbox"/> First Under Voltage Magnitude <input type="checkbox"/> First Under Voltage Trip Time <input type="checkbox"/> Over Frequency Magnitude <input type="checkbox"/> Over Frequency Trip Time <input type="checkbox"/> Response to Utility Recovery	
Test description:	33% load, PR: 0%, QC: +4%, trip time 360ms. Wave No. 1 was the output current of inverter; Wave No. 2 was the current through the grid, also regarded as trip signal while the grid was switched off.		

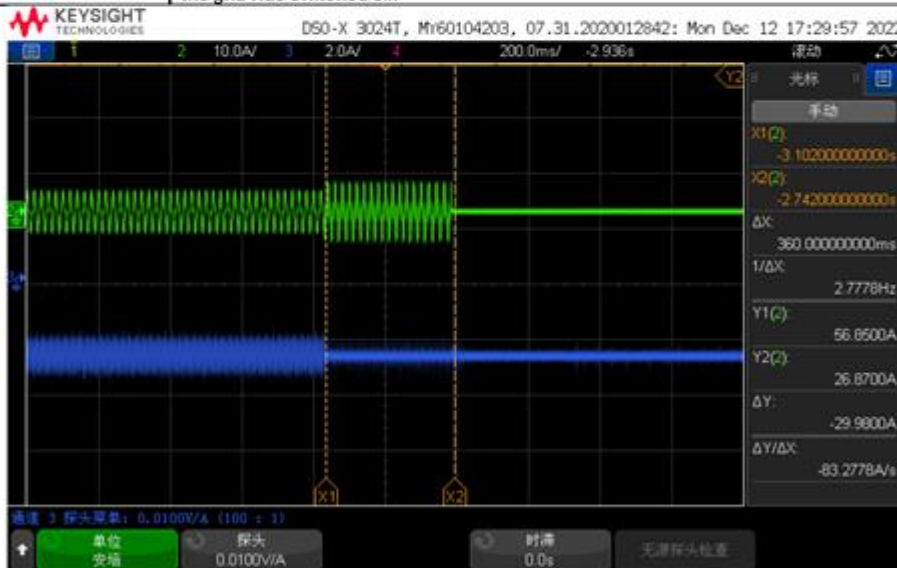

Used equipment No.: See equipment list for details Sample No.: N/A

Finished date: _____ Tested by: _____

Review date: _____ Reviewed by: _____



Compliance Evaluation Report



REPORT No.: CSSC/BOS/005

ISSUED DATE: March 9, 2023

APPENDIX C. TÜV Rheinland's Report No: CN23Y4BO 001. (Cont.)

Test Data / Test Plan		TÜVRheinland®	
TÜV Rheinland (Shanghai) Co., Ltd.		Document No.: TD-0189	
Protection and Control requirements for PEA Interface of Inverter based Generation Systems 2016.08		Report No:	CN23Y4BO 001
Order No. :	244466490	Product:	Grid-Connected PV Inverter
Client Name :	SolaX Power Network Technology (Zhejiang) Co., Ltd.	Model designation:	X1-MINI-1.5K-G4

Attachment : 1

Picture No.:	50	Clause:	7
Test:	<input checked="" type="checkbox"/> Islanding Protection <input type="checkbox"/> Secondary Over Voltage Magnitude <input type="checkbox"/> Secondary Over Voltage Trip Time <input type="checkbox"/> Secondary Under Voltage Magnitude <input type="checkbox"/> Secondary Under Voltage Trip Time <input type="checkbox"/> Under Frequency Magnitude <input type="checkbox"/> Under Frequency Trip Time		<input type="checkbox"/> First Over Voltage Magnitude <input type="checkbox"/> First Over Voltage Trip Time <input type="checkbox"/> First Under Voltage Magnitude <input type="checkbox"/> First Under Voltage Trip Time <input type="checkbox"/> Over Frequency Magnitude <input type="checkbox"/> Over Frequency Trip Time <input type="checkbox"/> Response to Utility Recovery
Test description:	33% load, PR: 0%, QC: +5%, trip time 352ms. Wave No. 1 was the output current of inverter; Wave No. 2 was the current through the grid, also regarded as trip signal while the grid was switched off.		

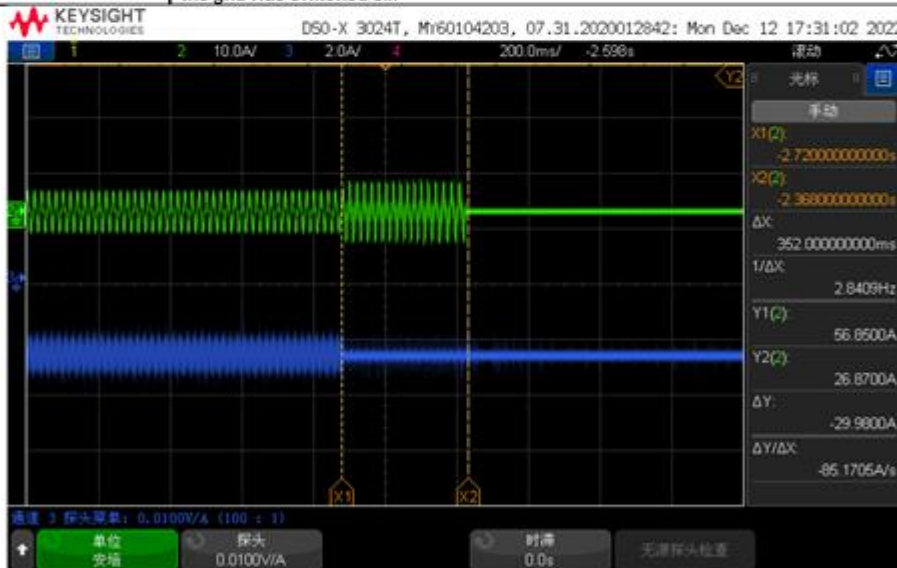

Used equipment No.: See equipment list for details Sample No.: N/A

Finished date: _____ Tested by: _____

Review date: _____ Reviewed by: _____



Compliance Evaluation Report



REPORT No.: CSSC/BOS/005

ISSUED DATE: March 9, 2023

APPENDIX C. TÜV Rheinland's Report No: CN23Y4BO 001. (Cont.)

Test Data / Test Plan			
TÜV Rheinland (Shanghai) Co., Ltd.		Document No.: TD-0189	
Protection and Control requirements for PEA Interface of Inverter based Generation Systems 2016.08		Report No:	CN23Y4BO 001
Order No. :	244466490	Product:	Grid-Connected PV Inverter
Client Name :	SolaX Power Network Technology (Zhejiang) Co., Ltd.	Model designation:	X1-MINI-1.5K-G4

Attachment : 1

Picture No.:	51	Clause:	8
Test:	<input type="checkbox"/> Islanding Protection <input type="checkbox"/> Secondary Over Voltage Magnitude <input type="checkbox"/> Secondary Over Voltage Trip Time <input type="checkbox"/> Secondary Under Voltage Magnitude <input type="checkbox"/> Secondary Under Voltage Trip Time <input type="checkbox"/> Under Frequency Magnitude <input type="checkbox"/> Under Frequency Trip Time <input type="checkbox"/> First Over Voltage Magnitude <input type="checkbox"/> First Over Voltage Trip Time <input type="checkbox"/> First Under Voltage Magnitude <input type="checkbox"/> First Under Voltage Trip Time <input type="checkbox"/> Over Frequency Magnitude <input type="checkbox"/> Over Frequency Trip Time <input checked="" type="checkbox"/> Response to Utility Recovery		
Test description:	Inverter won't reconnect to grid while the grid voltage remained over 242V after the over voltage protection was tripped; Wave No.1 was the grid voltage; Wave No.2 was the output current of inverter; Wave No.4 was the trip signal while the grid voltage changed.		

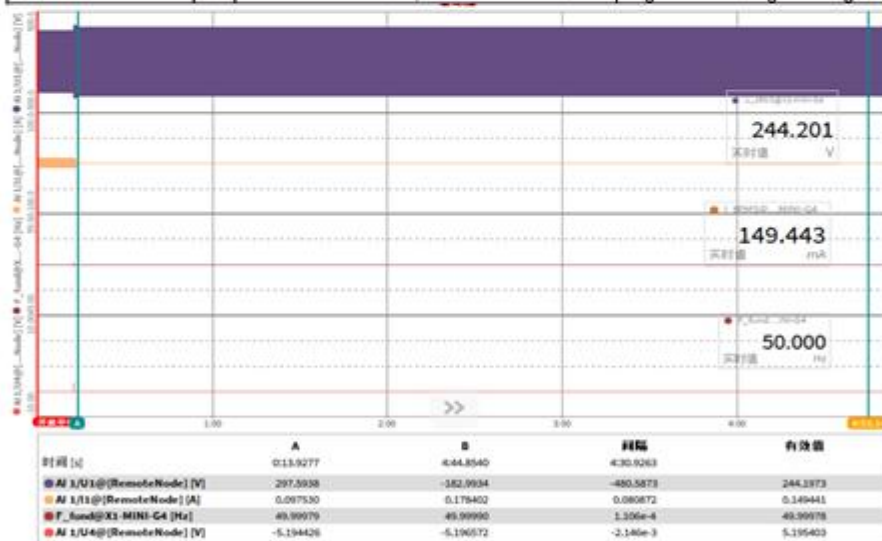

Used equipment No.: See equipment list for details Sample No.: N/A

Finished date: _____ Tested by: _____

Review date: _____ Reviewed by: _____



Compliance Evaluation Report



REPORT No.: CSSC/BOS/005

ISSUED DATE: March 9, 2023

APPENDIX C. TÜV Rheinland's Report No: CN23Y4BO 001. (Cont.)

Test Data / Test Plan			
TÜV Rheinland (Shanghai) Co., Ltd.		Document No.: TD-0189	
Protection and Control requirements for PEA Interface of Inverter based Generation Systems 2016.08		Report No:	CN23Y4BO 001
Order No. :	244466490	Product:	Grid-Connected PV Inverter
Client Name :	SolaX Power Network Technology (Zhejiang) Co., Ltd.	Model designation:	X1-MINI-1.5K-G4

Attachment : 1

Picture No.:	52	Clause:	8
Test:	<input type="checkbox"/> Islanding Protection <input type="checkbox"/> Secondary Over Voltage Magnitude <input type="checkbox"/> Secondary Over Voltage Trip Time <input type="checkbox"/> Secondary Under Voltage Magnitude <input type="checkbox"/> Secondary Under Voltage Trip Time <input type="checkbox"/> Under Frequency Magnitude <input type="checkbox"/> Under Frequency Trip Time <input type="checkbox"/> First Over Voltage Magnitude <input type="checkbox"/> First Over Voltage Trip Time <input type="checkbox"/> First Under Voltage Magnitude <input type="checkbox"/> First Under Voltage Trip Time <input type="checkbox"/> Over Frequency Magnitude <input type="checkbox"/> Over Frequency Trip Time <input checked="" type="checkbox"/> Response to Utility Recovery		
Test description:	Inverter reconnect to grid with 127.9s delay while grid voltage remained below 242V after the over voltage protection was tripped; Wave No. 1 was the grid voltage; Wave No.2 was the output current of inverter; Wave No.4 was the trip signal while the grid voltage changed.		

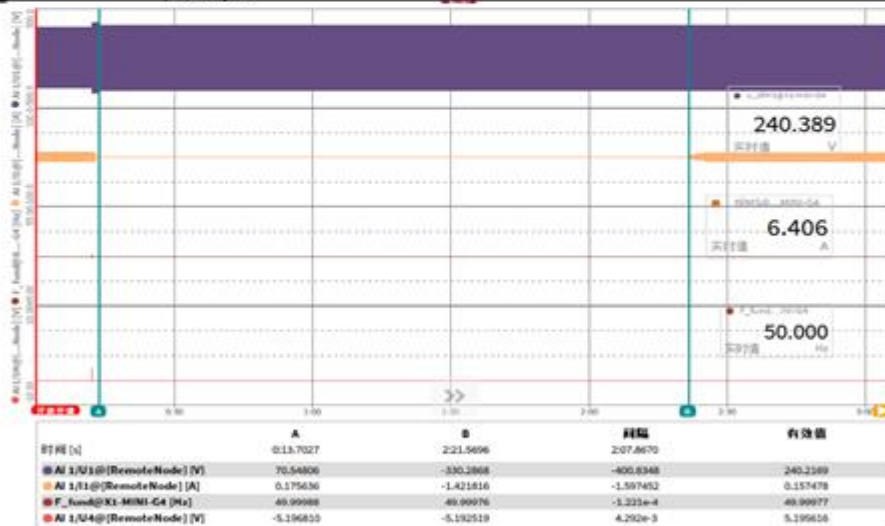

Used equipment No.: See equipment list for details Sample No.: N/A

Finished date: _____ Tested by: _____

Review date: _____ Reviewed by: _____



Compliance Evaluation Report



REPORT No.: CSSC/BOS/005

ISSUED DATE: March 9, 2023

APPENDIX C. TÜV Rheinland's Report No: CN23Y4BO 001. (Cont.)

Test Data / Test Plan			
TÜV Rheinland (Shanghai) Co., Ltd.		Document No.: TD-0189	
Protection and Control requirements for PEA Interface of Inverter based Generation Systems 2016.08		Report No:	CN23Y4BO 001
Order No. :	244466490	Product:	Grid-Connected PV Inverter
Client Name :	SolaX Power Network Technology (Zhejiang) Co., Ltd.	Model designation:	X1-MINI-1.5K-G4

Attachment : 1

Picture No.:	53	Clause:	8
Test:	<input type="checkbox"/> Islanding Protection <input type="checkbox"/> Secondary Over Voltage Magnitude <input type="checkbox"/> Secondary Over Voltage Trip Time <input type="checkbox"/> Secondary Under Voltage Magnitude <input type="checkbox"/> Secondary Under Voltage Trip Time <input type="checkbox"/> Under Frequency Magnitude <input type="checkbox"/> Under Frequency Trip Time <input type="checkbox"/> First Over Voltage Magnitude <input type="checkbox"/> First Over Voltage Trip Time <input type="checkbox"/> First Under Voltage Magnitude <input type="checkbox"/> First Under Voltage Trip Time <input type="checkbox"/> Over Frequency Magnitude <input type="checkbox"/> Over Frequency Trip Time <input checked="" type="checkbox"/> Response to Utility Recovery		
Test description:	Inverter won't reconnect to grid while the grid voltage remained under 198V after the under voltage protection was tripped; Wave No.1 was the grid voltage; Wave No.2 was the output current of inverter; Wave No.4 was the trip signal while the grid voltage changed.		

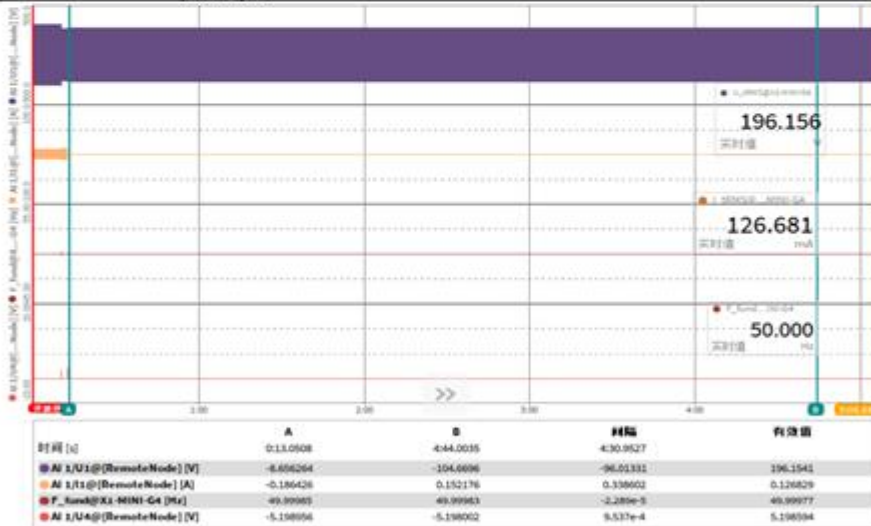

Used equipment No.: See equipment list for details Sample No.: N/A

Finished date: _____ Tested by: _____

Review date: _____ Reviewed by: _____



Compliance Evaluation Report



REPORT No.: CSSC/BOS/005

ISSUED DATE: March 9, 2023

APPENDIX C. TÜV Rheinland's Report No: CN23Y4BO 001. (Cont.)

Test Data / Test Plan		TÜVRheinland®	
TÜV Rheinland (Shanghai) Co., Ltd.		Document No.: TD-0189	
Protection and Control requirements for PEA Interface of Inverter based Generation Systems 2016.08		Report No:	CN23Y4BO 001
Order No. :	244466490	Product:	Grid-Connected PV Inverter
Client Name :	SolaX Power Network Technology (Zhejiang) Co., Ltd.	Model designation:	X1-MINI-1.5K-G4

Attachment : 1

Picture No.:	54	Clause:	8
Test:	<input type="checkbox"/> Islanding Protection <input type="checkbox"/> Secondary Over Voltage Magnitude <input type="checkbox"/> Secondary Over Voltage Trip Time <input type="checkbox"/> Secondary Under Voltage Magnitude <input type="checkbox"/> Secondary Under Voltage Trip Time <input type="checkbox"/> Under Frequency Magnitude <input type="checkbox"/> Under Frequency Trip Time	<input type="checkbox"/> First Over Voltage Magnitude <input type="checkbox"/> First Over Voltage Trip Time <input type="checkbox"/> First Under Voltage Magnitude <input type="checkbox"/> First Under Voltage Trip Time <input type="checkbox"/> Over Frequency Magnitude <input type="checkbox"/> Over Frequency Trip Time <input checked="" type="checkbox"/> Response to Utility Recovery	
Test description:	Inverter reconnect to grid with 126.9s delay while grid voltage remained above 198V after the under voltage protection was tripped; Wave No. 1 was the grid voltage; Wave No. 2 was the output current of inverter; Wave No. 4 was the trip signal while the grid voltage changed.		

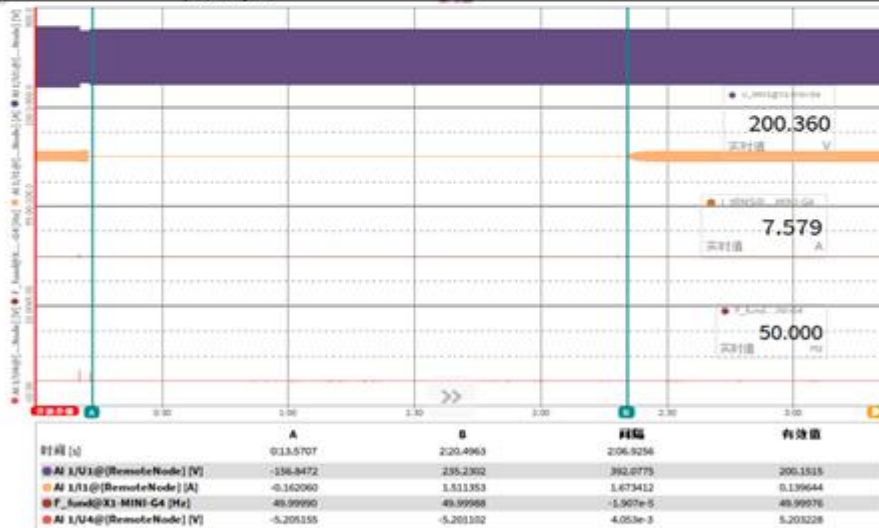

Used equipment No.: See equipment list for details Sample No.: N/A

Finished date: _____ Tested by: _____

Review date: _____ Reviewed by: _____



Compliance Evaluation Report



REPORT No.: CSSC/BOS/005

ISSUED DATE: March 9, 2023

APPENDIX C. TÜV Rheinland's Report No: CN23Y4BO 001. (Cont.)

Test Data / Test Plan		TÜVRheinland®	
TÜV Rheinland (Shanghai) Co., Ltd.		Document No.: TD-0189	
Protection and Control requirements for PEA Interface of Inverter based Generation Systems 2016.08		Report No:	CN23Y4BO 001
Order No. :	244466490	Product:	Grid-Connected PV Inverter
Client Name :	SolaX Power Network Technology (Zhejiang) Co., Ltd.	Model designation:	X1-MINI-1.5K-G4

Attachment : 1

Picture No.:	55	Clause:	8
Test:	<input type="checkbox"/> Islanding Protection <input type="checkbox"/> Secondary Over Voltage Magnitude <input type="checkbox"/> Secondary Over Voltage Trip Time <input type="checkbox"/> Secondary Under Voltage Magnitude <input type="checkbox"/> Secondary Under Voltage Trip Time <input type="checkbox"/> Under Frequency Magnitude <input type="checkbox"/> Under Frequency Trip Time		<input type="checkbox"/> First Over Voltage Magnitude <input type="checkbox"/> First Over Voltage Trip Time <input type="checkbox"/> First Under Voltage Magnitude <input type="checkbox"/> First Under Voltage Trip Time <input type="checkbox"/> Over Frequency Magnitude <input type="checkbox"/> Over Frequency Trip Time <input checked="" type="checkbox"/> Response to Utility Recovery
Test description:	Inverter won't reconnect to grid while the grid voltage frequency remained above 52Hz after the over frequency protection was tripped; Wave No. 1 was the grid voltage; Wave No.2 was the output current of inverter; Wave No.4 was the trip signal while the grid voltage changed.		

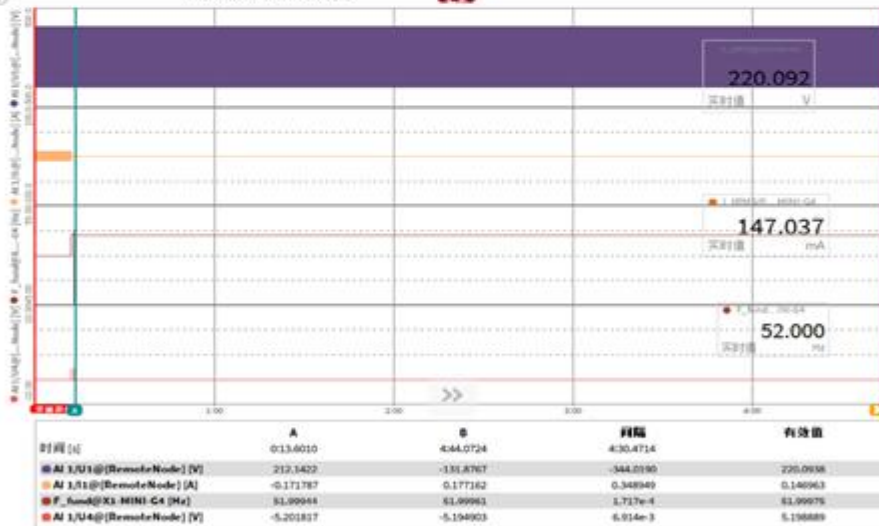

Used equipment No.: See equipment list for details Sample No.: N/A

Finished date: _____ Tested by: _____

Review date: _____ Reviewed by: _____



Compliance Evaluation Report



REPORT No.: CSSC/BOS/005

ISSUED DATE: March 9, 2023

APPENDIX C. TÜV Rheinland's Report No: CN23Y4BO 001. (Cont.)

Test Data / Test Plan		TÜVRheinland®	
TÜV Rheinland (Shanghai) Co., Ltd.		Document No.: TD-0189	
Protection and Control requirements for PEA Interface of Inverter based Generation Systems 2016.08		Report No:	CN23Y4BO 001
Order No. :	244466490	Product:	Grid-Connected PV Inverter
Client Name :	SolaX Power Network Technology (Zhejiang) Co., Ltd.	Model designation:	X1-MINI-1.5K-G4

Attachment : 1

Picture No.:	56	Clause:	8
Test:	<input type="checkbox"/> Islanding Protection <input type="checkbox"/> Secondary Over Voltage Magnitude <input type="checkbox"/> Secondary Over Voltage Trip Time <input type="checkbox"/> Secondary Under Voltage Magnitude <input type="checkbox"/> Secondary Under Voltage Trip Time <input type="checkbox"/> Under Frequency Magnitude <input type="checkbox"/> Under Frequency Trip Time <input type="checkbox"/> First Over Voltage Magnitude <input type="checkbox"/> First Over Voltage Trip Time <input type="checkbox"/> First Under Voltage Magnitude <input type="checkbox"/> First Under Voltage Trip Time <input type="checkbox"/> Over Frequency Magnitude <input type="checkbox"/> Over Frequency Trip Time <input checked="" type="checkbox"/> Response to Utility Recovery		
Test description:	Inverter reconnect to grid with 127.1s delay while grid voltage frequency remained below 52Hz after the over frequency protection was tripped; Wave No.1 was the grid voltage; Wave No.2 was the output current of inverter; Wave No.4 was the trip signal while the grid voltage changed.		



Used equipment No.: See equipment list for details Sample No.: N/A

Finished date: _____ Tested by: _____

Review date: _____ Reviewed by: _____



Compliance Evaluation Report



REPORT No.: CSSC/BOS/005

ISSUED DATE: March 9, 2023

APPENDIX C. TÜV Rheinland's Report No: CN23Y4BO 001. (Cont.)

Test Data / Test Plan		TÜVRheinland®	
TÜV Rheinland (Shanghai) Co., Ltd.		Document No.: TD-0189	
Protection and Control requirements for PEA Interface of Inverter based Generation Systems 2016.08		Report No:	CN23Y4BO 001
Order No. :	244466490	Product:	Grid-Connected PV Inverter
Client Name :	SolaX Power Network Technology (Zhejiang) Co., Ltd.	Model designation:	X1-MINI-1.5K-G4

Attachment : 1

Picture No.:	57	Clause:	8
Test:	<input type="checkbox"/> Islanding Protection <input type="checkbox"/> Secondary Over Voltage Magnitude <input type="checkbox"/> Secondary Over Voltage Trip Time <input type="checkbox"/> Secondary Under Voltage Magnitude <input type="checkbox"/> Secondary Under Voltage Trip Time <input type="checkbox"/> Under Frequency Magnitude <input type="checkbox"/> Under Frequency Trip Time		<input type="checkbox"/> First Over Voltage Magnitude <input type="checkbox"/> First Over Voltage Trip Time <input type="checkbox"/> First Under Voltage Magnitude <input type="checkbox"/> First Under Voltage Trip Time <input type="checkbox"/> Over Frequency Magnitude <input type="checkbox"/> Over Frequency Trip Time <input checked="" type="checkbox"/> Response to Utility Recovery
Test description:	Inverter won't reconnect to grid while the grid voltage frequency remained below 47Hz after the under frequency protection was tripped; Wave No.1 was the grid voltage; Wave No.2 was the output current of inverter; Wave No.4 was the trip signal while the grid voltage changed.		

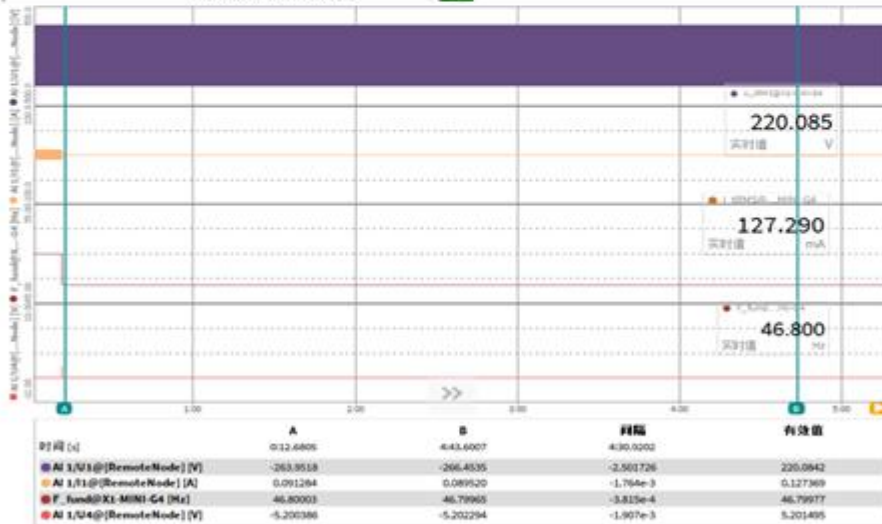

Used equipment No.: See equipment list for details Sample No.: N/A

Finished date: _____ Tested by: _____

Review date: _____ Reviewed by: _____



Compliance Evaluation Report



REPORT No.: CSSC/BOS/005

ISSUED DATE: March 9, 2023

APPENDIX C. TÜV Rheinland's Report No: CN23Y4BO 001. (Cont.)

Test Data / Test Plan		TÜVRheinland®	
TÜV Rheinland (Shanghai) Co., Ltd.		Document No.: TD-0189	
Protection and Control requirements for PEA Interface of Inverter based Generation Systems 2016.08		Report No:	CN23Y4BO 001
Order No. :	244466490	Product:	Grid-Connected PV Inverter
Client Name :	SolaX Power Network Technology (Zhejiang) Co., Ltd.	Model designation:	X1-MINI-1.5K-G4

Attachment : 1

Picture No.:	58	Clause:	8
Test:	<input type="checkbox"/> Islanding Protection <input type="checkbox"/> Secondary Over Voltage Magnitude <input type="checkbox"/> Secondary Over Voltage Trip Time <input type="checkbox"/> Secondary Under Voltage Magnitude <input type="checkbox"/> Secondary Under Voltage Trip Time <input type="checkbox"/> Under Frequency Magnitude <input type="checkbox"/> Under Frequency Trip Time	<input type="checkbox"/> First Over Voltage Magnitude <input type="checkbox"/> First Over Voltage Trip Time <input type="checkbox"/> First Under Voltage Magnitude <input type="checkbox"/> First Under Voltage Trip Time <input type="checkbox"/> Over Frequency Magnitude <input type="checkbox"/> Over Frequency Trip Time <input checked="" type="checkbox"/> Response to Utility Recovery	
Test description:	Inverter reconnect to grid with 127.1s delay while grid voltage frequency remained over 47Hz after the over frequency protection was tripped; Wave No.1 was the grid voltage; Wave No.2 was the output current of inverter; Wave No.4 was the trip signal while the grid voltage changed.		

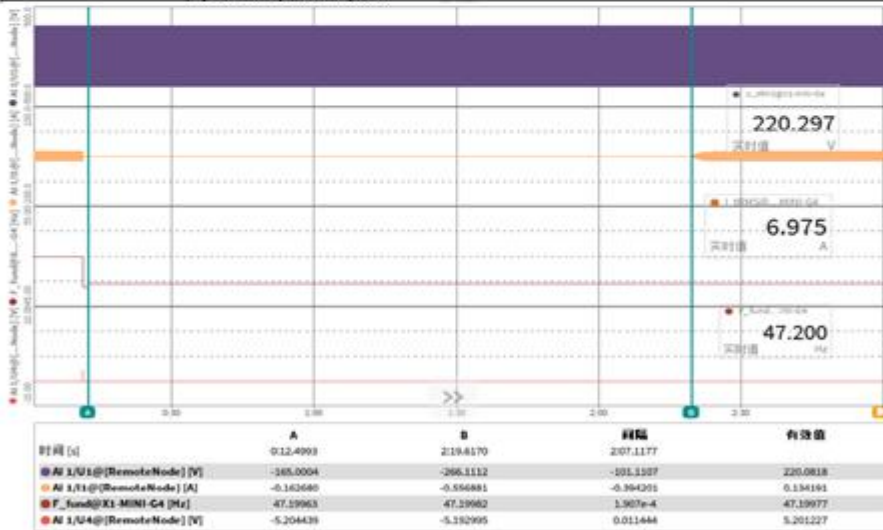

Used equipment No.: See equipment list for details Sample No.: N/A

Finished date: _____ Tested by: _____

Review date: _____ Reviewed by: _____



Compliance Evaluation Report



REPORT No.: CSSC/BOS/005

ISSUED DATE: March 9, 2023

APPENDIX C. TÜV Rheinland's Report No: CN23Y4BO 001. (Cont.)

Test Data / Test Plan		TÜVRheinland®	
TÜV Rheinland (Shanghai) Co., Ltd.		Document No.: TD-0189	
Protection and Control requirements for PEA Interface of Inverter based Generation Systems 2016.08		Report No:	CN23Y4BO 001
Order No. :	244466490	Product:	Grid-Connected PV Inverter
Client Name :	SolaX Power Network Technology (Zhejiang) Co., Ltd.	Model designation:	X1-MINI-1.5K-G4

Attachment : 1

Picture No.:	59	Clause:	8
Test:	<input type="checkbox"/> Islanding Protection <input type="checkbox"/> Secondary Over Voltage Magnitude <input type="checkbox"/> Secondary Over Voltage Trip Time <input type="checkbox"/> Secondary Under Voltage Magnitude <input type="checkbox"/> Secondary Under Voltage Trip Time <input type="checkbox"/> Under Frequency Magnitude <input type="checkbox"/> Under Frequency Trip Time		<input type="checkbox"/> First Over Voltage Magnitude <input type="checkbox"/> First Over Voltage Trip Time <input type="checkbox"/> First Under Voltage Magnitude <input type="checkbox"/> First Under Voltage Trip Time <input type="checkbox"/> Over Frequency Magnitude <input type="checkbox"/> Over Frequency Trip Time <input checked="" type="checkbox"/> Response to Utility Recovery
Test description:	Inverter reconnect to grid with 127.5s delay while grid voltage remained below 242V. The grid voltage jumped over 242V again during the countdown period after the over voltage protection was tripped; Wave No. 1 was the grid voltage; Wave No.2 was the output current of inverter; Wave No.4 was the trip signal while the grid voltage changed.		



Used equipment No.: See equipment list for details Sample No.: N/A

Finished date: _____ Tested by: _____

Review date: _____ Reviewed by: _____



Compliance Evaluation Report



REPORT No.: CSSC/BOS/005

ISSUED DATE: March 9, 2023

APPENDIX C. TÜV Rheinland's Report No: CN23Y4BO 001. (Cont.)

Test Data / Test Plan		TÜVRheinland®	
TÜV Rheinland (Shanghai) Co., Ltd.		Document No.: TD-0189	
Protection and Control requirements for PEA Interface of Inverter based Generation Systems 2016.08		Report No:	CN23Y4BO 001
Order No. :	244466490	Product:	Grid-Connected PV Inverter
Client Name :	SolaX Power Network Technology (Zhejiang) Co., Ltd.	Model designation:	X1-MINI-1.5K-G4

Attachment : 1

Picture No.:	60	Clause:	8
Test:	<input type="checkbox"/> Islanding Protection <input type="checkbox"/> Secondary Over Voltage Magnitude <input type="checkbox"/> Secondary Over Voltage Trip Time <input type="checkbox"/> Secondary Under Voltage Magnitude <input type="checkbox"/> Secondary Under Voltage Trip Time <input type="checkbox"/> Under Frequency Magnitude <input type="checkbox"/> Under Frequency Trip Time		<input type="checkbox"/> First Over Voltage Magnitude <input type="checkbox"/> First Over Voltage Trip Time <input type="checkbox"/> First Under Voltage Magnitude <input type="checkbox"/> First Under Voltage Trip Time <input type="checkbox"/> Over Frequency Magnitude <input type="checkbox"/> Over Frequency Trip Time <input checked="" type="checkbox"/> Response to Utility Recovery
Test description:	Inverter reconnect to grid with 127.3s delay while grid voltage remained above 198V. The grid voltage jump below 198V again during the countdown period after the under voltage protection was tripped; Wave No. 1 was the grid voltage; Wave No.2 was the output current of inverter; Wave No.4 was the trip signal while the grid voltage changed.		

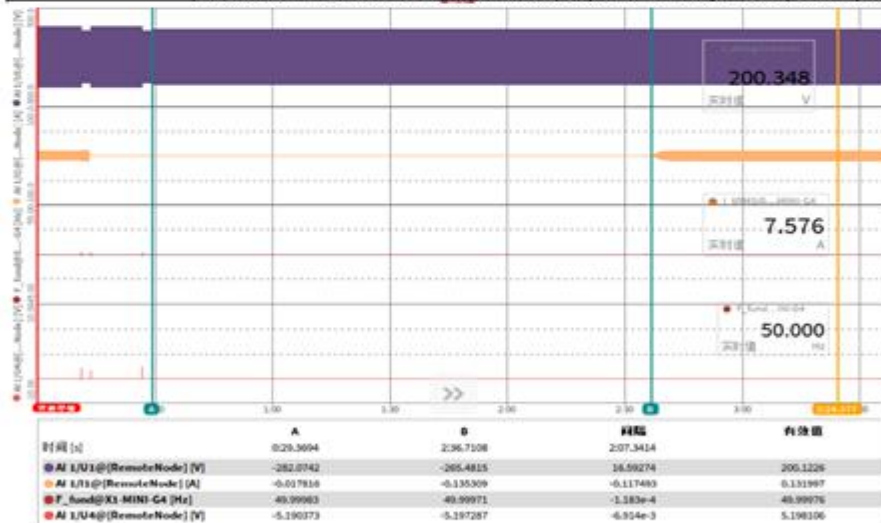

Used equipment No.: See equipment list for details Sample No.: N/A

Finished date: _____ Tested by: _____

Review date: _____ Reviewed by: _____



Compliance Evaluation Report



REPORT No.: CSSC/BOS/005

ISSUED DATE: March 9, 2023

APPENDIX C. TÜV Rheinland's Report No: CN23Y4BO 001. (Cont.)

Test Data / Test Plan		TÜVRheinland®	
TÜV Rheinland (Shanghai) Co., Ltd.		Document No.: TD-0189	
Protection and Control requirements for PEA Interface of Inverter based Generation Systems 2016.08		Report No:	CN23Y4BO 001
Order No. :	244466490	Product:	Grid-Connected PV Inverter
Client Name :	SolaX Power Network Technology (Zhejiang) Co., Ltd.	Model designation:	X1-MINI-1.5K-G4

Attachment : 1

Picture No.:	61	Clause:	8
Test:	<input type="checkbox"/> Islanding Protection <input type="checkbox"/> Secondary Over Voltage Magnitude <input type="checkbox"/> Secondary Over Voltage Trip Time <input type="checkbox"/> Secondary Under Voltage Magnitude <input type="checkbox"/> Secondary Under Voltage Trip Time <input type="checkbox"/> Under Frequency Magnitude <input type="checkbox"/> Under Frequency Trip Time	<input type="checkbox"/> First Over Voltage Magnitude <input type="checkbox"/> First Over Voltage Trip Time <input type="checkbox"/> First Under Voltage Magnitude <input type="checkbox"/> First Under Voltage Trip Time <input type="checkbox"/> Over Frequency Magnitude <input type="checkbox"/> Over Frequency Trip Time <input checked="" type="checkbox"/> Response to Utility Recovery	
Test description:	Inverter reconnect to grid with 127.4s delay while grid voltage frequency remained below 52Hz. The grid voltage frequency jumped over 52Hz again during the countdown period after the under frequency protection was tripped; Wave No.1 was the grid voltage; Wave No.3 was the output current of inverter; Wave No.4 was the trip signal while the grid voltage changed.		



Used equipment No.: See equipment list for details Sample No.: N/A

Finished date: _____ Tested by: _____

Review date: _____ Reviewed by: _____



Compliance Evaluation Report



REPORT No.: CSSC/BOS/005

ISSUED DATE: March 9, 2023

APPENDIX C. TÜV Rheinland's Report No: CN23Y4BO 001. (Cont.)

Test Data / Test Plan		TÜVRheinland®	
TÜV Rheinland (Shanghai) Co., Ltd.		Document No.: TD-0189	
Protection and Control requirements for PEA Interface of Inverter based Generation Systems 2016.08		Report No:	CN23Y4BO 001
Order No. :	244466490	Product:	Grid-Connected PV Inverter
Client Name :	SolaX Power Network Technology (Zhejiang) Co., Ltd.	Model designation:	X1-MINI-1.5K-G4

Attachment : 1

Picture No.:	62	Clause:	8
Test:	<input type="checkbox"/> Islanding Protection <input type="checkbox"/> Secondary Over Voltage Magnitude <input type="checkbox"/> Secondary Over Voltage Trip Time <input type="checkbox"/> Secondary Under Voltage Magnitude <input type="checkbox"/> Secondary Under Voltage Trip Time <input type="checkbox"/> Under Frequency Magnitude <input type="checkbox"/> Under Frequency Trip Time		<input type="checkbox"/> First Over Voltage Magnitude <input type="checkbox"/> First Over Voltage Trip Time <input type="checkbox"/> First Under Voltage Magnitude <input type="checkbox"/> First Under Voltage Trip Time <input type="checkbox"/> Over Frequency Magnitude <input type="checkbox"/> Over Frequency Trip Time <input checked="" type="checkbox"/> Response to Utility Recovery
Test description:	Inverter reconnect to grid with 127.4s delay while grid voltage frequency remained above 47Hz. The grid voltage frequency jumped below 47Hz again during the countdown period after the under frequency protection was tripped; Wave No.1 was the grid voltage; Wave No.2 was the output current of inverter; Wave No.4 was the trip signal while the grid voltage changed.		

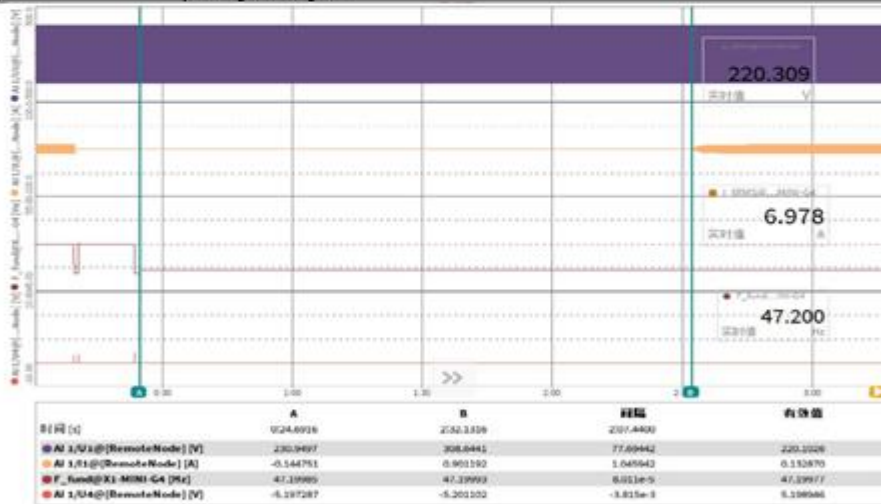

Used equipment No.: See equipment list for details Sample No.: N/A

Finished date: _____ Tested by: _____

Review date: _____ Reviewed by: _____



Compliance Evaluation Report



REPORT No.: CSSC/BOS/005

ISSUED DATE: March 9, 2023

APPENDIX C. TÜV Rheinland's Report No: CN23Y4BO 001. (Cont.)

Test Data / Test Plan		TÜVRheinland®	
TÜV Rheinland (Shanghai) Co., Ltd.		Document No.: TD-0189	
Protection and Control requirements for PEA Interface of Inverter based Generation Systems 2016.08		Report No:	CN23Y4BO 001
Order No. :	244466490	Product:	Grid-Connected PV Inverter
Client Name :	SolaX Power Network Technology (Zhejiang) Co., Ltd.	Model designation:	X1-MINI-1.5K-G4

Attachment : 1

Picture No.:	63	Clause:	9
Test:	<input type="checkbox"/> Islanding Protection <input type="checkbox"/> Secondary Over Voltage Magnitude <input type="checkbox"/> Secondary Over Voltage Trip Time <input type="checkbox"/> Secondary Under Voltage Magnitude <input type="checkbox"/> Secondary Under Voltage Trip Time <input type="checkbox"/> Under Frequency Magnitude <input type="checkbox"/> Under Frequency Trip Time		<input checked="" type="checkbox"/> First Over Voltage Magnitude <input checked="" type="checkbox"/> First Over Voltage Trip Time <input type="checkbox"/> First Under Voltage Magnitude <input type="checkbox"/> First Under Voltage Trip Time <input type="checkbox"/> Over Frequency Magnitude <input type="checkbox"/> Over Frequency Trip Time <input type="checkbox"/> Response to Utility Recovery
Test description:	During the first level over voltage test , the trip time was 127.5ms , the grid voltage was jumped to 267.3V approximately. Wave No.1 was the grid voltage; Wave No.2 was the output current of inverter; Wave No.4 was the trip signal while the grid voltage changed.		

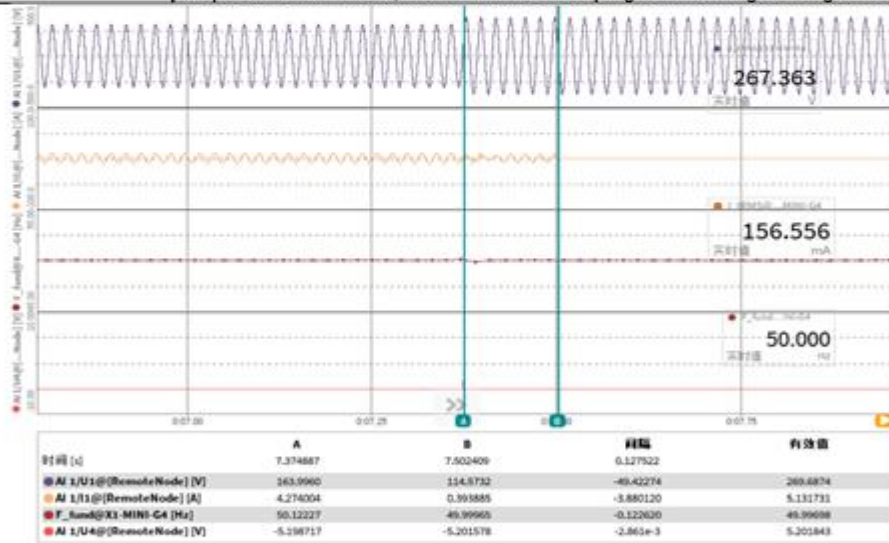

Used equipment No.: See equipment list for details Sample No.: N/A

Finished date: _____ Tested by: _____

Review date: _____ Reviewed by: _____



Compliance Evaluation Report



REPORT No.: CSSC/BOS/005

ISSUED DATE: March 9, 2023

APPENDIX C. TÜV Rheinland's Report No: CN23Y4BO 001. (Cont.)

Test Data / Test Plan		TÜVRheinland®	
TÜV Rheinland (Shanghai) Co., Ltd.		Document No.: TD-0189	
Protection and Control requirements for PEA Interface of Inverter based Generation Systems 2016.08		Report No:	CN23Y4BO 001
Order No. :	244466490	Product:	Grid-Connected PV Inverter
Client Name :	SolaX Power Network Technology (Zhejiang) Co., Ltd.	Model designation:	X1-MINI-1.5K-G4

Attachment : 1

Picture No.:	64	Clause:	9
Test:	<input type="checkbox"/> Islanding Protection <input type="checkbox"/> Secondary Over Voltage Magnitude <input type="checkbox"/> Secondary Over Voltage Trip Time <input type="checkbox"/> Secondary Under Voltage Magnitude <input type="checkbox"/> Secondary Under Voltage Trip Time <input type="checkbox"/> Under Frequency Magnitude <input type="checkbox"/> Under Frequency Trip Time		<input checked="" type="checkbox"/> First Over Voltage Magnitude <input checked="" type="checkbox"/> First Over Voltage Trip Time <input type="checkbox"/> First Under Voltage Magnitude <input type="checkbox"/> First Under Voltage Trip Time <input type="checkbox"/> Over Frequency Magnitude <input type="checkbox"/> Over Frequency Trip Time <input type="checkbox"/> Response to Utility Recovery
Test description:	During the first level over voltage test , the trip time was 124.8ms , the grid voltage was jumped to 267.3V approximately. Wave No.1 was the grid voltage; Wave No.2 was the output current of inverter; Wave No.4 was the trip signal while the grid voltage changed.		

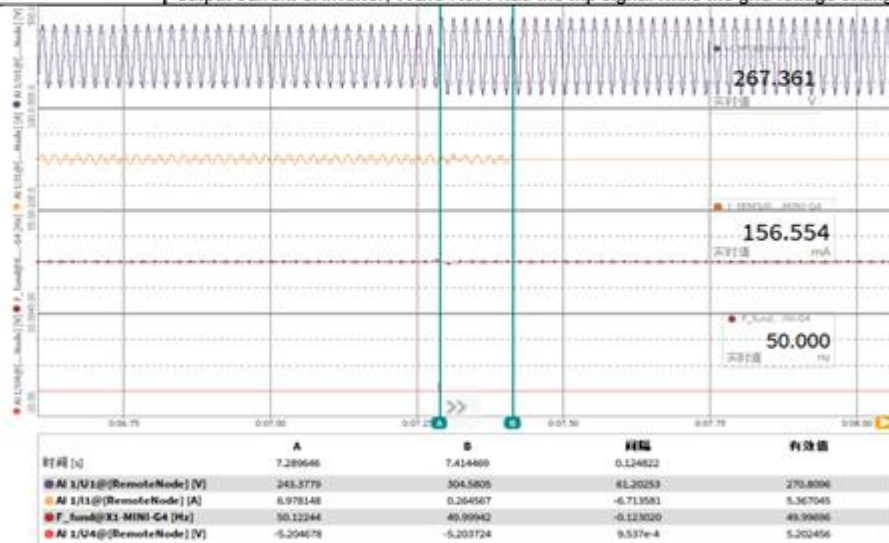

Used equipment No.: See equipment list for details Sample No.: N/A
 Finished date: _____ Tested by: _____
 Review date: _____ Reviewed by: _____



Compliance Evaluation Report



REPORT No.: CSSC/BOS/005

ISSUED DATE: March 9, 2023

APPENDIX C. TÜV Rheinland's Report No: CN23Y4BO 001. (Cont.)

Test Data / Test Plan		TÜVRheinland®	
TÜV Rheinland (Shanghai) Co., Ltd.		Document No.: TD-0189	
Protection and Control requirements for PEA Interface of Inverter based Generation Systems 2016.08		Report No:	CN23Y4BO 001
Order No. :	244466490	Product:	Grid-Connected PV Inverter
Client Name :	SolaX Power Network Technology (Zhejiang) Co., Ltd.	Model designation:	X1-MINI-1.5K-G4

Attachment : 1

Picture No.:	65	Clause:	9
Test:	<input type="checkbox"/> Islanding Protection <input checked="" type="checkbox"/> Secondary Over Voltage Magnitude <input checked="" type="checkbox"/> Secondary Over Voltage Trip Time <input type="checkbox"/> Secondary Under Voltage Magnitude <input type="checkbox"/> Secondary Under Voltage Trip Time <input type="checkbox"/> Under Frequency Magnitude <input type="checkbox"/> Under Frequency Trip Time		<input type="checkbox"/> First Over Voltage Magnitude <input type="checkbox"/> First Over Voltage Trip Time <input type="checkbox"/> First Under Voltage Magnitude <input type="checkbox"/> First Under Voltage Trip Time <input type="checkbox"/> Over Frequency Magnitude <input type="checkbox"/> Over Frequency Trip Time <input type="checkbox"/> Response to Utility Recovery
Test description:	During the second level over voltage test , the trip time was 28.7ms, the grid voltage was jumped to 290.4V approximately. Wave No.1 was the grid voltage; Wave No.2 was the output current of inverter; Wave No.4 was the trip signal while the grid voltage changed.		

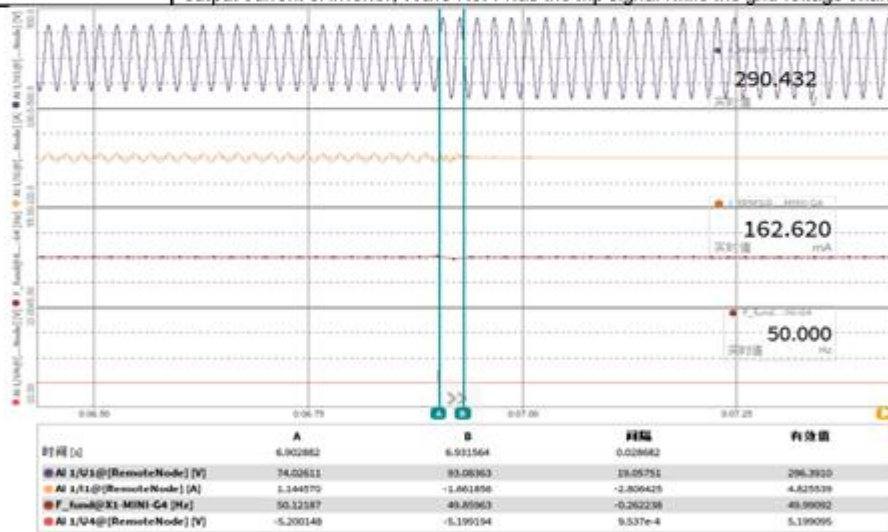

Used equipment No.: See equipment list for details Sample No.: N/A
 Finished date: _____ Tested by: _____
 Review date: _____ Reviewed by: _____



Compliance Evaluation Report



REPORT No.: CSSC/BOS/005

ISSUED DATE: March 9, 2023

APPENDIX C. TÜV Rheinland's Report No: CN23Y4BO 001. (Cont.)

Test Data / Test Plan		TÜVRheinland®	
TÜV Rheinland (Shanghai) Co., Ltd.		Document No.: TD-0189	
Protection and Control requirements for PEA Interface of Inverter based Generation Systems 2016.08		Report No:	CN23Y4BO 001
Order No. :	244466490	Product:	Grid-Connected PV Inverter
Client Name :	SolaX Power Network Technology (Zhejiang) Co., Ltd.	Model designation:	X1-MINI-1.5K-G4

Attachment : 1

Picture No.:	66	Clause:	9
Test:	<input type="checkbox"/> Islanding Protection <input checked="" type="checkbox"/> Secondary Over Voltage Magnitude <input checked="" type="checkbox"/> Secondary Over Voltage Trip Time <input type="checkbox"/> Secondary Under Voltage Magnitude <input type="checkbox"/> Secondary Under Voltage Trip Time <input type="checkbox"/> Under Frequency Magnitude <input type="checkbox"/> Under Frequency Trip Time		<input type="checkbox"/> First Over Voltage Magnitude <input type="checkbox"/> First Over Voltage Trip Time <input type="checkbox"/> First Under Voltage Magnitude <input type="checkbox"/> First Under Voltage Trip Time <input type="checkbox"/> Over Frequency Magnitude <input type="checkbox"/> Over Frequency Trip Time <input type="checkbox"/> Response to Utility Recovery
Test description:	During the second level over voltage test , the trip time was 27.6ms, the grid voltage was jumped to 290.4V approximately. Wave No.1 was the grid voltage; Wave No.2 was the output current of inverter; Wave No.4 was the trip signal while the grid voltage changed.		

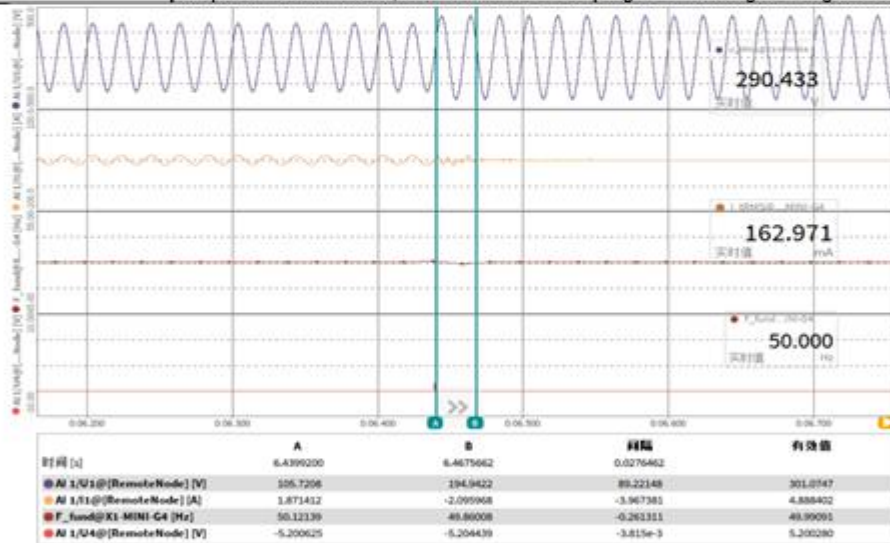

Used equipment No.: See equipment list for details Sample No.: N/A

Finished date: _____ Tested by: _____

Review date: _____ Reviewed by: _____



Compliance Evaluation Report



REPORT No.: CSSC/BOS/005

ISSUED DATE: March 9, 2023

APPENDIX C. TÜV Rheinland's Report No: CN23Y4BO 001. (Cont.)

Test Data / Test Plan		TÜVRheinland®	
TÜV Rheinland (Shanghai) Co., Ltd.		Document No.: TD-0189	
Protection and Control requirements for PEA Interface of Inverter based Generation Systems 2016.08		Report No:	CN23Y4BO 001
Order No. :	244466490	Product:	Grid-Connected PV Inverter
Client Name :	SolaX Power Network Technology (Zhejiang) Co., Ltd.	Model designation:	X1-MINI-1.5K-G4

Attachment : 1

Picture No.:	67	Clause:	9
Test:	<input type="checkbox"/> Islanding Protection <input type="checkbox"/> Secondary Over Voltage Magnitude <input type="checkbox"/> Secondary Over Voltage Trip Time <input type="checkbox"/> Secondary Under Voltage Magnitude <input type="checkbox"/> Secondary Under Voltage Trip Time <input type="checkbox"/> Under Frequency Magnitude <input type="checkbox"/> Under Frequency Trip Time		<input type="checkbox"/> First Over Voltage Magnitude <input type="checkbox"/> First Over Voltage Trip Time <input checked="" type="checkbox"/> First Under Voltage Magnitude <input checked="" type="checkbox"/> First Under Voltage Trip Time <input type="checkbox"/> Over Frequency Magnitude <input type="checkbox"/> Over Frequency Trip Time <input type="checkbox"/> Response to Utility Recovery
Test description:	During the first level under voltage test , the trip time was 1964.4ms, the grid voltage was jumped to 177.3V approximately. Wave No.1 was the grid voltage; Wave No.2 was the output current of inverter; Wave No.4 was the trip signal while the grid voltage changed.		

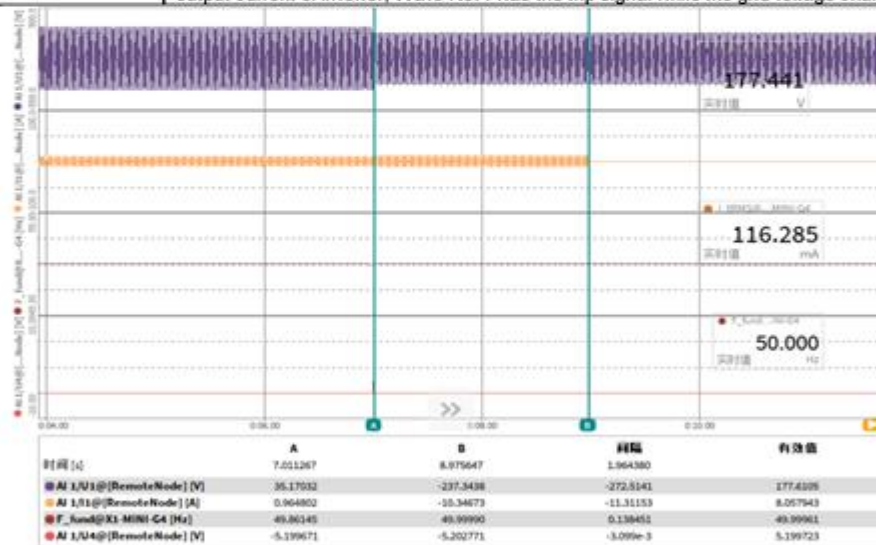

Used equipment No.: See equipment list for details Sample No.: N/A

Finished date: _____ Tested by: _____

Review date: _____ Reviewed by: _____



Compliance Evaluation Report



REPORT No.: CSSC/BOS/005

ISSUED DATE: March 9, 2023

APPENDIX C. TÜV Rheinland's Report No: CN23Y4BO 001. (Cont.)

Test Data / Test Plan		TÜVRheinland®	
TÜV Rheinland (Shanghai) Co., Ltd.		Document No.: TD-0189	
Protection and Control requirements for PEA Interface of Inverter based Generation Systems 2016.08		Report No:	CN23Y4BO 001
Order No. :	244466490	Product:	Grid-Connected PV Inverter
Client Name :	SolaX Power Network Technology (Zhejiang) Co., Ltd.	Model designation:	X1-MINI-1.5K-G4

Attachment : 1

Picture No.:	68	Clause:	9
Test:	<input type="checkbox"/> Islanding Protection <input type="checkbox"/> Secondary Over Voltage Magnitude <input type="checkbox"/> Secondary Over Voltage Trip Time <input type="checkbox"/> Secondary Under Voltage Magnitude <input type="checkbox"/> Secondary Under Voltage Trip Time <input type="checkbox"/> Under Frequency Magnitude <input type="checkbox"/> Under Frequency Trip Time		<input type="checkbox"/> First Over Voltage Magnitude <input type="checkbox"/> First Over Voltage Trip Time <input checked="" type="checkbox"/> First Under Voltage Magnitude <input checked="" type="checkbox"/> First Under Voltage Trip Time <input type="checkbox"/> Over Frequency Magnitude <input type="checkbox"/> Over Frequency Trip Time <input type="checkbox"/> Response to Utility Recovery
Test description:	During the first level under voltage test , the trip time was 1963.5ms, the grid voltage was jumped to 177.3V approximately. Wave No.1 was the grid voltage; Wave No.2 was the output current of inverter; Wave No.4 was the trip signal while the grid voltage changed.		



Used equipment No.: See equipment list for details Sample No.: N/A

Finished date: _____ Tested by: _____

Review date: _____ Reviewed by: _____



Compliance Evaluation Report



REPORT No.: CSSC/BOS/005

ISSUED DATE: March 9, 2023

APPENDIX C. TÜV Rheinland's Report No: CN23Y4BO 001. (Cont.)

Test Data / Test Plan		TÜVRheinland®	
TÜV Rheinland (Shanghai) Co., Ltd.		Document No.: TD-0189	
Protection and Control requirements for PEA Interface of Inverter based Generation Systems 2016.08		Report No:	CN23Y4BO 001
Order No. :	244466490	Product:	Grid-Connected PV Inverter
Client Name :	SolaX Power Network Technology (Zhejiang) Co., Ltd.	Model designation:	X1-MINI-1.5K-G4

Attachment : 1

Picture No.:	67	Clause:	9
Test:	<input type="checkbox"/> Islanding Protection <input type="checkbox"/> Secondary Over Voltage Magnitude <input type="checkbox"/> Secondary Over Voltage Trip Time <input checked="" type="checkbox"/> Secondary Under Voltage Magnitude <input checked="" type="checkbox"/> Secondary Under Voltage Trip Time <input type="checkbox"/> Under Frequency Magnitude <input type="checkbox"/> Under Frequency Trip Time		<input type="checkbox"/> First Over Voltage Magnitude <input type="checkbox"/> First Over Voltage Trip Time <input type="checkbox"/> First Under Voltage Magnitude <input type="checkbox"/> First Under Voltage Trip Time <input type="checkbox"/> Over Frequency Magnitude <input type="checkbox"/> Over Frequency Trip Time <input type="checkbox"/> Response to Utility Recovery
Test description:	During the second level under voltage test, the trip time was 269.8ms, the grid voltage was jumped to 98.1V approximately. Wave No.1 was the grid voltage; Wave No.2 was the output current of inverter; Wave No.4 was the trip signal while the grid voltage changed.		

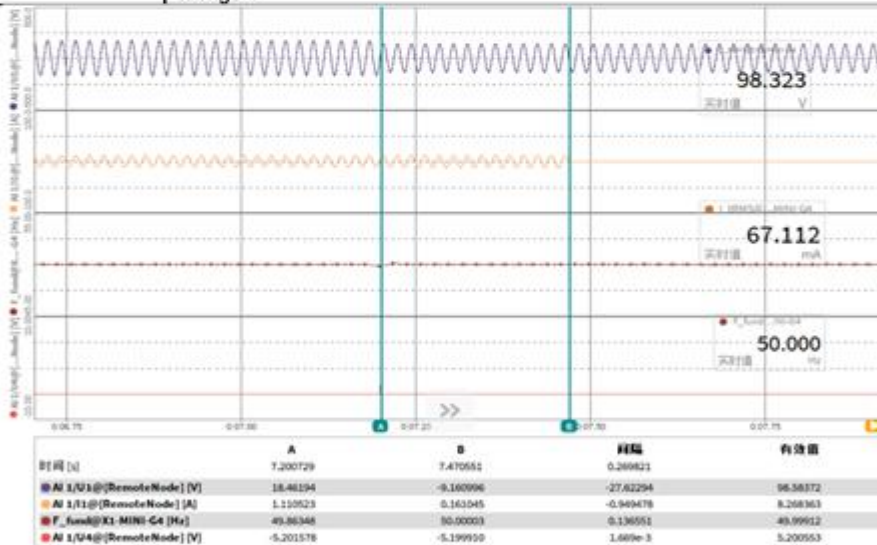

Used equipment No.: See equipment list for details Sample No.: N/A

Finished date: _____ Tested by: _____

Review date: _____ Reviewed by: _____



Compliance Evaluation Report



REPORT No.: CSSC/BOS/005

ISSUED DATE: March 9, 2023

APPENDIX C. TÜV Rheinland's Report No: CN23Y4BO 001. (Cont.)

Test Data / Test Plan		TÜVRheinland®	
TÜV Rheinland (Shanghai) Co., Ltd.		Document No.: TD-0189	
Protection and Control requirements for PEA Interface of Inverter based Generation Systems 2016.08		Report No:	CN23Y4BO 001
Order No. :	244466490	Product:	Grid-Connected PV Inverter
Client Name :	SolaX Power Network Technology (Zhejiang) Co., Ltd.	Model designation:	X1-MINI-1.5K-G4

Attachment : 1

Picture No.:	68	Clause:	9
Test:	<input type="checkbox"/> Islanding Protection <input type="checkbox"/> Secondary Over Voltage Magnitude <input type="checkbox"/> Secondary Over Voltage Trip Time <input checked="" type="checkbox"/> Secondary Under Voltage Magnitude <input checked="" type="checkbox"/> Secondary Under Voltage Trip Time <input type="checkbox"/> Under Frequency Magnitude <input type="checkbox"/> Under Frequency Trip Time		<input type="checkbox"/> First Over Voltage Magnitude <input type="checkbox"/> First Over Voltage Trip Time <input type="checkbox"/> First Under Voltage Magnitude <input type="checkbox"/> First Under Voltage Trip Time <input type="checkbox"/> Over Frequency Magnitude <input type="checkbox"/> Over Frequency Trip Time <input type="checkbox"/> Response to Utility Recovery
Test description:	During the second level under voltage test, the trip time was 266.9ms, the grid voltage was jumped to 98.1V approximately. Wave No.1 was the grid voltage; Wave No.2 was the output current of inverter; Wave No.4 was the trip signal while the grid voltage changed.		

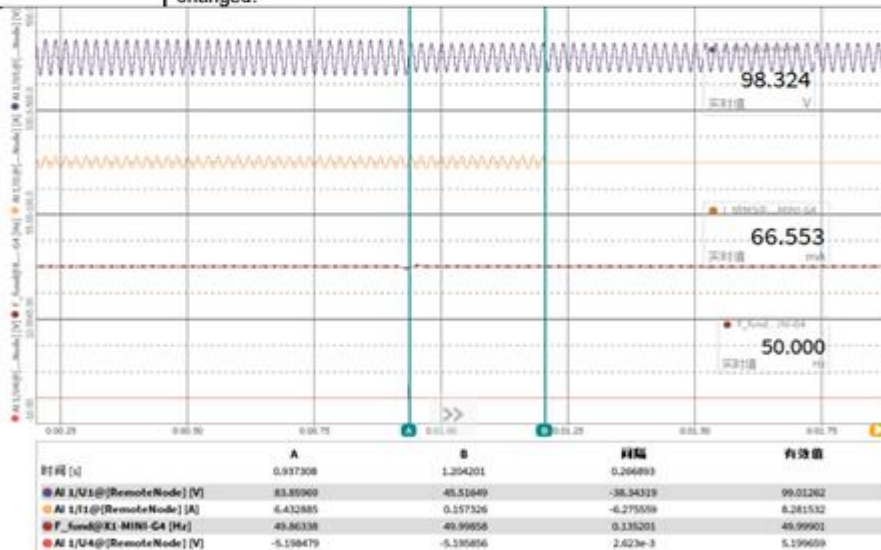

Used equipment No.: See equipment list for details Sample No.: N/A

Finished date: _____ Tested by: _____

Review date: _____ Reviewed by: _____



Compliance Evaluation Report



REPORT No.: CSSC/BOS/005

ISSUED DATE: March 9, 2023

APPENDIX C. TÜV Rheinland's Report No: CN23Y4BO 001. (Cont.)

Test Data / Test Plan		TÜVRheinland®	
TÜV Rheinland (Shanghai) Co., Ltd.		Document No.: TD-0189	
Protection and Control requirements for PEA Interface of Inverter based Generation Systems 2016.08		Report No:	CN23Y4BO 001
Order No. :	244466490	Product:	Grid-Connected PV Inverter
Client Name :	SolaX Power Network Technology (Zhejiang) Co., Ltd.	Model designation:	X1-MINI-1.5K-G4

Attachment : 1

Picture No.:	69	Clause:	10
Test:	<input type="checkbox"/> Islanding Protection <input type="checkbox"/> Secondary Over Voltage Magnitude <input type="checkbox"/> Secondary Over Voltage Trip Time <input type="checkbox"/> Secondary Under Voltage Magnitude <input type="checkbox"/> Secondary Under Voltage Trip Time <input type="checkbox"/> Under Frequency Magnitude <input type="checkbox"/> Under Frequency Trip Time		<input type="checkbox"/> First Over Voltage Magnitude <input type="checkbox"/> First Over Voltage Trip Time <input type="checkbox"/> First Under Voltage Magnitude <input type="checkbox"/> First Under Voltage Trip Time <input checked="" type="checkbox"/> Over Frequency Magnitude <input checked="" type="checkbox"/> Over Frequency Trip Time <input type="checkbox"/> Response to Utility Recovery
Test description:	During the over frequency test, the trip time was 62.7ms, the grid voltage frequency jumped to 52.6Hz approximately. The wave No.1 was the grid voltage; The wave No.2 was the output current of the inverter; The wave No.4 was the trip signal while the grid voltage changed.		

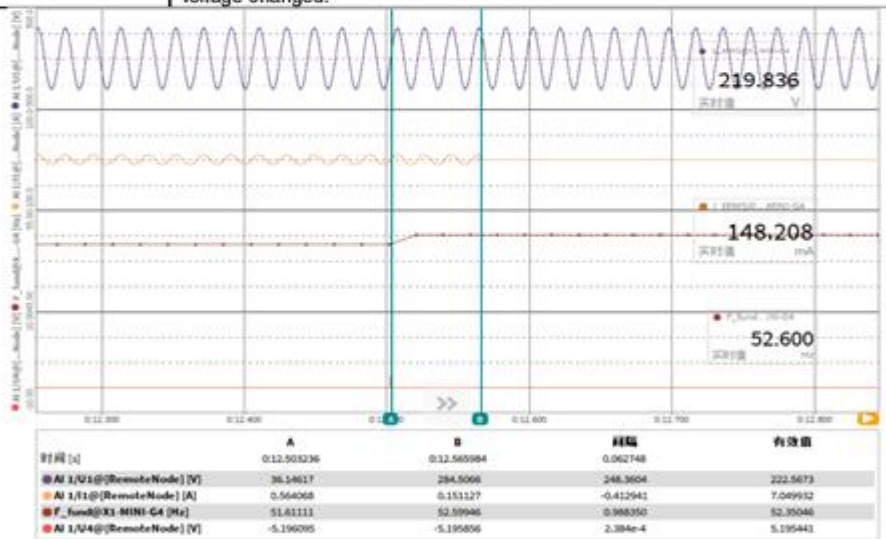

Used equipment No.: See equipment list for details Sample No.: N/A

Finished date: _____ Tested by: _____

Review date: _____ Reviewed by: _____



Compliance Evaluation Report



REPORT No.: CSSC/BOS/005

ISSUED DATE: March 9, 2023

APPENDIX C. TÜV Rheinland's Report No: CN23Y4BO 001. (Cont.)

Test Data / Test Plan		TÜVRheinland®	
TÜV Rheinland (Shanghai) Co., Ltd.		Document No.: TD-0189	
Protection and Control requirements for PEA Interface of Inverter based Generation Systems 2016.08		Report No:	CN23Y4BO 001
Order No. :	244466490	Product:	Grid-Connected PV Inverter
Client Name :	SolaX Power Network Technology (Zhejiang) Co., Ltd.	Model designation:	X1-MINI-1.5K-G4

Attachment : 1

Picture No.:	70	Clause:	10
Test:	<input type="checkbox"/> Islanding Protection <input type="checkbox"/> Secondary Over Voltage Magnitude <input type="checkbox"/> Secondary Over Voltage Trip Time <input type="checkbox"/> Secondary Under Voltage Magnitude <input type="checkbox"/> Secondary Under Voltage Trip Time <input checked="" type="checkbox"/> Under Frequency Magnitude <input checked="" type="checkbox"/> Under Frequency Trip Time		<input type="checkbox"/> First Over Voltage Magnitude <input type="checkbox"/> First Over Voltage Trip Time <input type="checkbox"/> First Under Voltage Magnitude <input type="checkbox"/> First Under Voltage Trip Time <input type="checkbox"/> Over Frequency Magnitude <input type="checkbox"/> Over Frequency Trip Time <input type="checkbox"/> Response to Utility Recovery
Test description:	During the under frequency test, the trip time was 60.7ms, the grid voltage frequency jumped to 46.4Hz approximately. The wave No.1 was the grid voltage; The wave No.2 was the output current of the inverter; The wave No.4 was the trip signal while the grid voltage changed.		

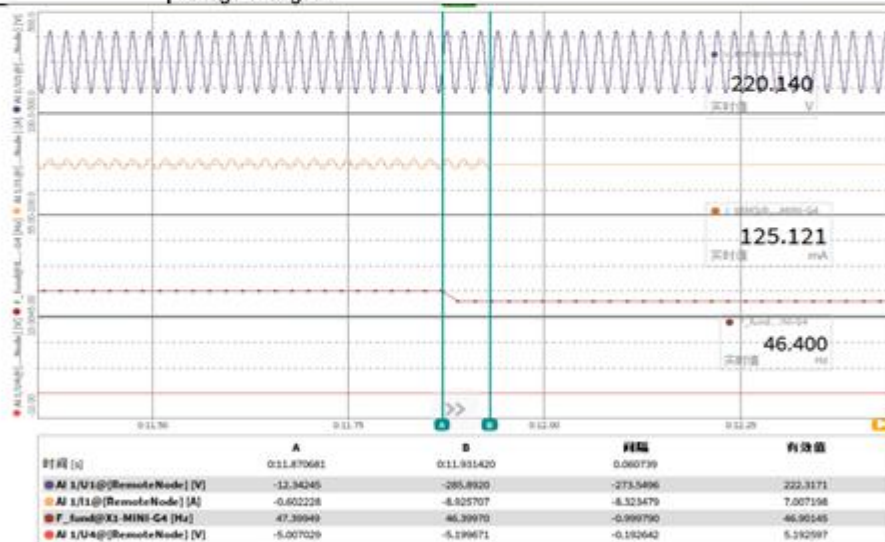

Used equipment No.: See equipment list for details Sample No.: N/A

Finished date: _____ Tested by: _____

Review date: _____ Reviewed by: _____



Compliance Evaluation Report



REPORT No.: CSSC/BOS/005

ISSUED DATE: March 9, 2023

APPENDIX C. TÜV Rheinland's Report No: CN23Y4BO 001. (Cont.)

Test Data / Test Plan			
TÜV Rheinland (Shanghai) Co., Ltd.		Document No.: TD-0189	
Protection and Control requirements for PEA Interface of Inverter based Generation Systems 2016.08		Report No:	CN23Y4BO 001
Order No. :	244466490	Product:	Grid-Connected PV Inverter
Client Name :	SolaX Power Network Technology (Zhejiang) Co., Ltd.	Model designation:	X1-MINI-1.5K-G4

Attachment : 1

Remark: Trip signal of each test		
1.	Under/over frequency test	The trip signal on the wave diagram was given by the AC source. For each operation on AC source a voltage signal would be given out. (from high level change to low level or from low level change to high level). In this test, we push the button on interface of AC source to change the simulated grid voltage frequency while a trip signal was given out to Oscilloscope automatically.
2.	Response to Utility Recovery	The trip signal on the wave diagram was given by the AC source. For each operation on AC source a voltage signal would be given out. (from high level change to low level or from low level change to high level). In this test, we push the button on interface of AC source to change the simulated grid voltage or voltage frequency while a trip signal was given out to Oscilloscope automatically.
3.	Islanding protection	In this test the trip signal was the current flowing to the grid. When the grid were not disconnected yet, a little current remained even in 100% balance condition, in which case the fundamental current is close to zero, but harmonic component still remains. While the grid is disconnected the grid current would disappeared thoroughly. So it's easy to find the moment while the grid is disconnected by the wave of grid current. The grid current as well as the inverter output current may appear impulses after the switch S2 released or the inverter cease to energize. It was caused not by the real current, but by the electromagnetic noise which may impact the current transducer appearing very small pulse signal while there is no real current flowing through it.

Used equipment No.: See equipment list for details Sample No.: N/A
 Finished date: _____ Tested by: _____
 Review date: _____ Reviewed by: _____



Compliance Evaluation Report



REPORT No.: CSSC/BOS/005

ISSUED DATE: March 9, 2023

APPENDIX C. TÜV Rheinland's Report No: CN23Y4BO 001. (Cont.)

Test Data / Test Plan			
TÜV Rheinland (Shanghai) Co., Ltd.		Document No.: TD-0189	
Protection and Control requirements for PEA Interface of Inverter based Generation Systems 2016.08		Report No:	CN23Y4BO 001
Order No. :	244466490	Product:	Grid-Connected PV Inverter
Client Name :	SolaX Power Network Technology (Zhejiang) Co., Ltd.	Model designation:	X1-MINI-1.5K-G4

Attachment : 1

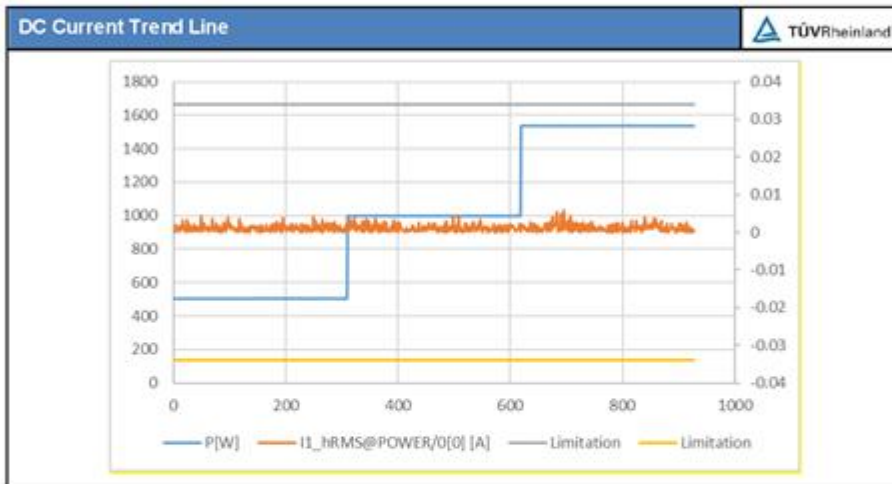

Used equipment No.: See equipment list for details Sample No.: N/A
 Finished date: _____ Tested by: _____
 Review date: _____ Reviewed by: _____



Compliance Evaluation Report



REPORT No.: CSSC/BOS/005

ISSUED DATE: March 9, 2023

APPENDIX C. TÜV Rheinland's Report No: CN23Y4BO 001. (Cont.)

Test Data / Test Plan			
TÜV Rheinland (Shanghai) Co., Ltd.		Document No.: TD-0189	
Protection and Control requirements for PEA Interface of Inverter based Generation Systems 2016.08		Report No:	CN23Y4BO 001
Order No. :	244466490	Product:	Grid-Connected PV Inverter
Client Name :	SolaX Power Network Technology (Zhejiang) Co., Ltd.	Model designation:	X1-MINI-1.5K-G4

Attachment : 1

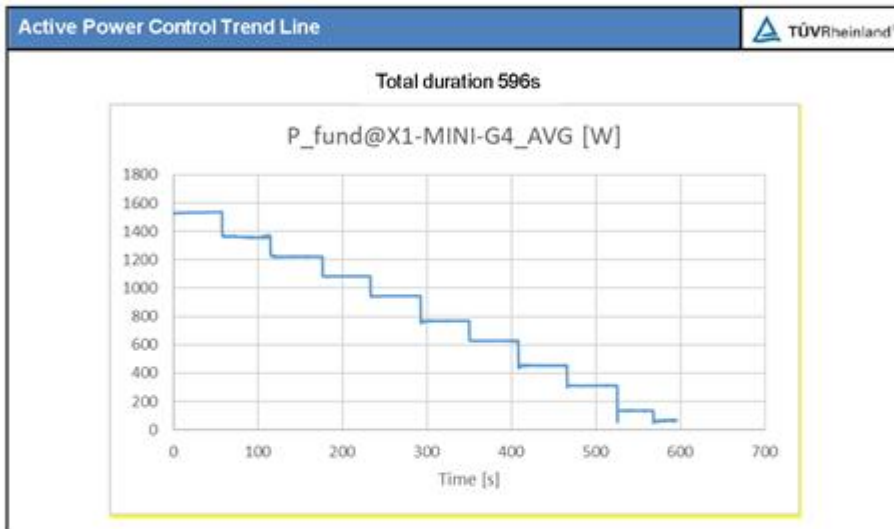

Used equipment No.: See equipment list for details Sample No.: N/A

Finished date: _____ Tested by: _____

Review date: _____ Reviewed by: _____



Compliance Evaluation Report



REPORT No.: CSSC/BOS/005

ISSUED DATE: March 9, 2023

APPENDIX C. TÜV Rheinland's Report No: CN23Y4BO 001. (Cont.)

TÜV Rheinland (Shanghai) Co. Ltd.
QMA 30.041.01SHG_7.14



Measurement and Test Equipment List
Used MTE

Revision: 20 July, 2007/ G.Luebken

Attachment: 2

Report No.: CN23Y4BO 001

Order No.: 244466490

Equip.	Description	Model	Manufacturer
9017073	Power Analyser(DEWETRON)	DEWE2-PA7	Austria, DEWETRON
9017074	Current Sensor(For WT3000)	IT 200-S	LEM
9017075	Current Sensor(For WT3000)	IT 200-S	LEM
9017076	Current Sensor(For WT3000)	IT 200-S	LEM
9017077	Current Sensor(For WT3000)	IT 200-S	LEM
9017078	Programmable AC Source(61860)	61860	Chroma ATE INC.
9017080	Oscilloscope	MDO3024	Tektronix
G1819265	ScopeCoder	DL850	JAPAN, Yokogawa
G1819266	Power Analyser(WT3000)	WT3000	JAPAN, Yokogawa
G1819267	T-Power Software	TP100-P-LVHA/STP	JAPAN, Yokogawa
G1819268	Anti-islanding test detection devices	ACL-4830H	QUNLING Energy Resources
G1819269	Harmonic impedance analog flicker system	ACL-6150	QUNLING Energy Resources
G1819277	PV array simulator	62150H-1000S	Chroma Co.
G1819278	PV array simulator	62150H-1000S	Chroma Co.
G1819279	PV array simulator	62150H-1000S	Chroma Co.
G1819280	PV array simulator	62150H-1000S	Chroma Co.

Used equipment No.: See equipment list for details

Sample No.: N/A

Finished date: _____

Tested by: _____

Review date: _____

Reviewed by: _____



Compliance Evaluation Report



REPORT No.: CSSC/BOS/005

ISSUED DATE: March 9, 2023

APPENDIX C. TÜV Rheinland's Report No: CN23Y4BO 001. (Cont.)

Attachment 3:
Report Number: Photo Documents
Model: CN23Y4BO 001
X1-MINI-1.5K-G4





Compliance Evaluation Report



REPORT No.: CSSC/BOS/005

ISSUED DATE: March 9, 2023

APPENDIX C. TÜV Rheinland's Report No: CN23Y4BO 001. (Cont.)

Attachment 3:
Report Number: Photo Documents
Model: CN23Y4BO 001
X1-MINI-1.5K-G4

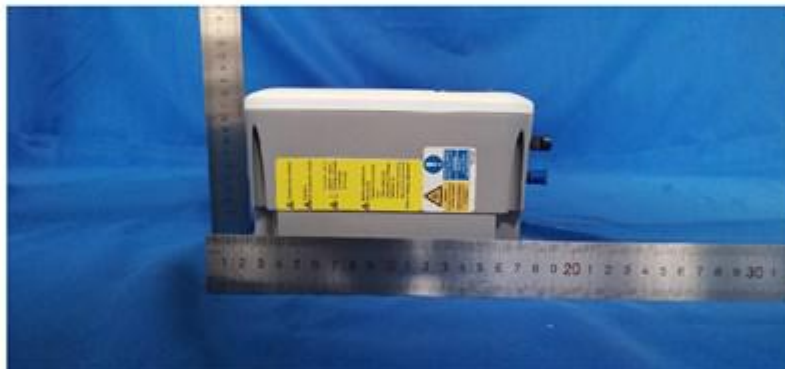
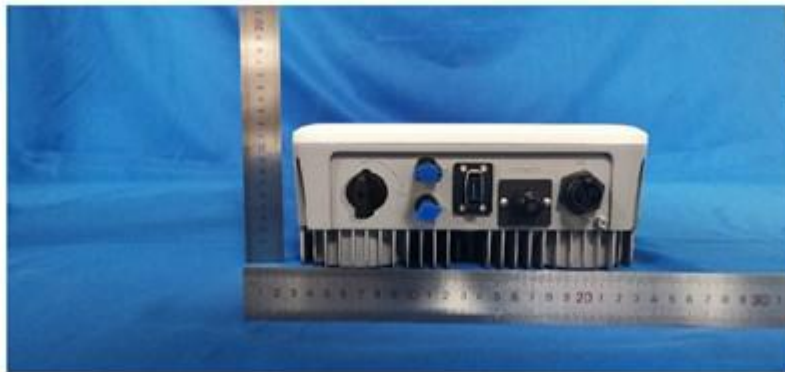



Compliance Evaluation Report



REPORT No.: CSSC/BOS/005

ISSUED DATE: March 9, 2023

APPENDIX C. TÜV Rheinland's Report No: CN23Y4BO 001. (Cont.)

Attachment 3:
Report Number: CN23Y4BO 001
Model: X1-MINI-1.5K-G4





Compliance Evaluation Report



REPORT No.: CSSC/BOS/005

ISSUED DATE: March 9, 2023

APPENDIX D. Laboratory Accreditation Certificate No. CNAS L3038.



China National Accreditation Service for Conformity Assessment LABORATORY ACCREDITATION CERTIFICATE (Registration No. CNAS L3038)

TUV Rheinland (Shanghai) Co., Ltd.

(Legal Entity: TUV Rheinland (Shanghai) Co., Ltd.)

1/F. of No.10, No.153/165/177/178/179/182/189/192/198, Lane 777,

Guangzhong West Road, Jing'an District, Shanghai, China

is accredited in accordance with ISO/IEC 17025: 2017 General Requirements for the Competence of Testing and Calibration Laboratories(CNAS-CL01 Accreditation Criteria for the Competence of Testing and Calibration Laboratories) for the competence to undertake the service described in the schedule attached to this certificate.

The scope of accreditation is detailed in the attached schedule bearing the same registration number as above. The schedule forms an integral part of this certificate.

Effective Date: 2019-10-30

Expiry Date: 2023-11-18

Signed on behalf of China National Accreditation Service for Conformity Assessment

China National Accreditation Service for Conformity Assessment (CNAS) is authorized by Certification and Accreditation Administration of the People's Republic of China (CNCA) to operate the national accreditation schemes for conformity assessment. CNAS is a signatory of the International Laboratory Accreditation Cooperation Mutual Recognition Arrangement (ILAC MRA) and the Asia Pacific Accreditation Cooperation Mutual Recognition Arrangement (APAC MRA).
The validity of the certificate can be checked on CNAS website at <http://www.cnas.org.cn/english/findanaccreditedbody/index.shtml>.